User manual M3

Potentiometer >1kΩ...<1000kΩ



Technical features:

- red display of -19999...99999 digits (optional: green, orange or blue display)
- minimal installation depth: 90 mm without plug-in screw terminal
- min/max-memory
- 30 additional adjustable supporting points
- display flashing at threshold value exceedance / threshold value undercut
- navigation keys for triggering of Hold, Tara
- permanent min/max-value recording
- volume metering (Totaliser)
- mathematic functions like reciprocal value, square root, squaring or rounding
- setpoint generator
- sliding average determination
- brightness control
- programming interlock via access code
- protection class IP65 at the front side
- plug-in screw terminal
- optional: 2 PhotoMos outputs
- optional: analog output
- optional: galvanic isolated digital input
- accessories: PC-based configuration-kit PM-TOOL with CD & USB-adapter for devices without keypad and for a simple adjustment of standard devices

Identification

STANDARD-TYPES	ORDERING NUMBER
Potentiometer	M3-7VR5A.0005.S70xD
Housing size: 48x24 mm	M3-7VR5A.0005.770xD

Options – breakdown of order code:

	M	3-	7	V	R	5	A.	0	0	0	5.	7	7	0	x	D		
Standard type M-line																		Dimension
																		<input type="checkbox"/> D physical unit
Installation depth																		Version
120 mm, incl. plug-in terminal			<input type="checkbox"/> 3															<input type="checkbox"/> x internal version
Housing size																		Switching points
48x24x90 mm (BxHxD)			<input type="checkbox"/> 7															<input type="checkbox"/> 0 no switching points
																		<input type="checkbox"/> 2 2 PhotoMos outputs
Display type																		Portection class
Potentiometer				<input type="checkbox"/> V														<input type="checkbox"/> 1 without keypad, operation via PM-TOOL
Display colour																		<input type="checkbox"/> 7 IP65 / plug-in terminal
Blue																		
Green																		
Red																		
Orange																		
																		Supply voltage
Number of digits																		<input type="checkbox"/> 7 24 VDC galv. isolated
5-digit																		<input type="checkbox"/> S 100-240 VAC
																		Measuring input
																		<input type="checkbox"/> 5 Potentiometer
Digit height																		Analog output
10 mm																		<input type="checkbox"/> 0 without
																		<input type="checkbox"/> X 0-10 VDC, 0/4-20 mA
Digitalinput																		Sensor supply
without																		<input type="checkbox"/> 0 without
1 digital input																		

Please state physical unit by order, e.g %

Contents

1. Brief description	2
2. Assembly	2
3. Electrical connection	3
4. Functions and operation description	4
4.1. Programming software PM-TOOL	5
5. Setting up the device	6
5.1. Switching on	6
5.2. Standard parameterisation (flat operation level)	6
Value assignment for triggering of the signal input	
5.3. Programming interlock „RUN“	9
Activation/deactivation of the programming interlock or change into the professional level respectively back into the flat operation level	
5.4. Extended parameterisation (professional operation level)	9
5.4.1. Signal input parameter „INP“	9
Value assignment for triggering of the signal input incl. linearisation	
5.4.2. General device parameter „FCT“	12
Superior device functions like Hold, Tara, min/max permanent, setpoint function respectively nominal value function, average determination, brightness control, as well as the control of the digital input and the keyboard configuration	
5.4.3. Safety parameter „COD“	16
Assignment of user and master code for locking or access to certain parameters like e.g. analog output and alarms, etc.	
5.4.4. Analog output parameter „OUT“	17
Analog output functions	
5.4.5. Relay functions „REL“	19
Parameter for the definition of the setpoints	
5.4.6. Alarm parameter „RL1...RL4“	22
Activator and dependencies of the alarms	
5.4.7. Totaliser (Volume metering) „TOT“	23
Parameter for calculation of the sum function	
6. Reset to factory settings	24
Reset of the parameter to the factory default settings	
7. Alarms / Relays	25
Function principle of the switching outputs	
8. Sensor alignment	26
Function diagram for sensors with existing trimming resistor	
9. Technical data	27
10. Safety advices	29
11. Error elimination	30

1. Brief description

The panel meter **M3-75** is a 5-digit device for potentiometer values of $>1\text{k}\Omega$ to $<1000\text{k}\Omega$ and a visual threshold value monitoring via the display. The configuration happens via 4 front keys or via the optional PC-software PM-TOOL. An integrated programming interlock prevents unrequested changes of the parameters and can be released again by an individual code. Optional the following functions are available: a digital input for triggering of Hold (Tara) or an analog output for further processing in the equipment.

By use of the 2 optional galvanic isolated setpoints, free adjustable threshold values can be controlled and reported to a superior master display. The electrical connection is carried out on the back side via plug-in terminals.

Selectable functions like e.g. the request of the min/max-value, an average determination of the measuring signals, a nominal preset respectively setpoint preset, a direct change of threshold value in operation mode and additional measuring supporting points for linearisation complete the modern device concept.

2. Assembly

Please read the *Safety advices* on page 29 before installation and keep this user manual for future reference.

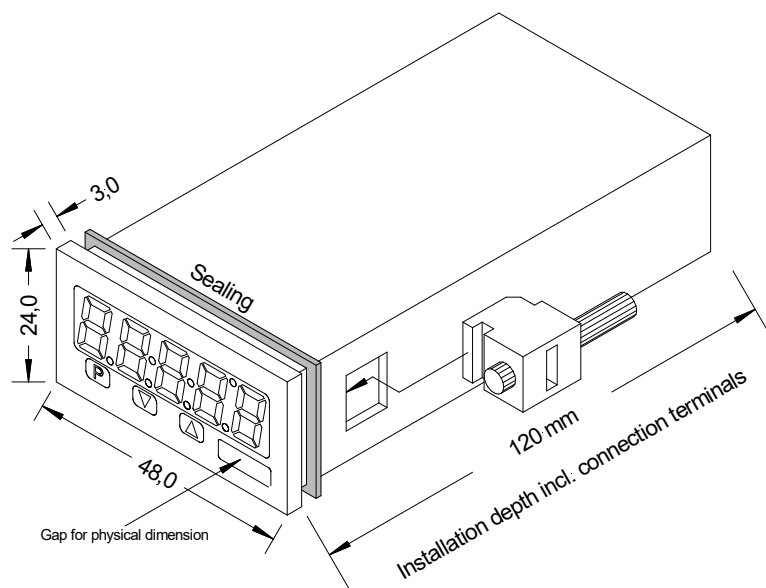

1. After removing the fixing elements, insert the device.
2. Check the seal to make sure it fits securely.
3. Click the fixing elements back into place and tighten the clamping screws by hand. Then use a screwdriver to tighten them another half a turn.

CAUTION! The torque should not exceed 0.1 Nm!

Change signs of the physical unit before assembly via a channel at the side of the front!

The change can only be done from the outside before assembly!

3. Electrical connection

Type M3-7VR5A.0005.S70xD
supply of 100-240 VAC

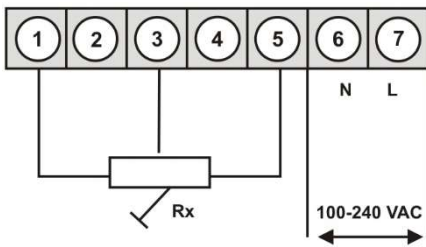

Type M3-7VR5A.0005.770xD
supply of 24 VDC

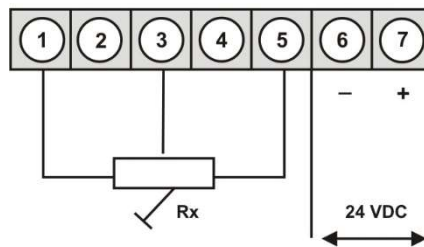

Options:

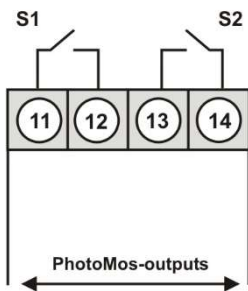

Options:

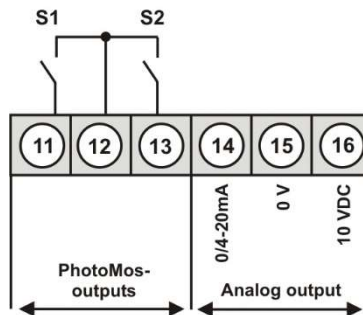

alternatively to
analog output

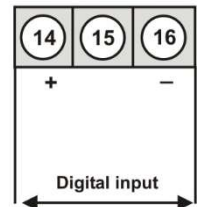

Connection examples

Below you find one connection example, which demonstrates the practical application of the digital input.

M3 with digital input and external voltage source

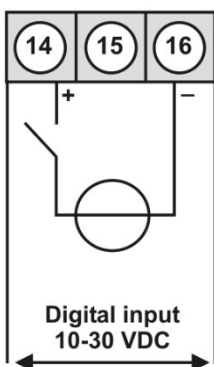

4. Function and operation description

Operation

The operation is divided into three different levels.

Menu level (delivery status)















The menu level was designed for the standard settings of the device. Only menu items which are sufficient to set the device into operation are displayed. To get into the professional level, run through the menu level and parameterise *PROF* under menu item *RUN*.

Menu group level (complete function volume)

Suited for complex applications as e.g. linkage of alarms, setpoint treatment, totaliser function etc. In this level, function groups which allow an extended parameterisation of the standard settings are available. To leave the menu group level, run through this level and parameterise *ULOC* under menu item *RUN*.

Parameterisation level:

Parameter deposited in the menu item can here be parameterised. Functions, that can be changed or adjusted, are always signalled by a flashing of the display. Settings that are made in the parameterisation level are confirmed with **[P]** and thus saved. Pressing the **[O]**-key („zero-key“) leads to a break-off of the value input and to a change into the menu level. All adjustments are saved automatically by the device and it changes into operating mode, if no further key operation is done within the next 10 seconds.

Level	Key	Description
Menu level		Change to parameterisation level and deposited values.
	 	Keys for up and down navigation in the menu level.
	 	Change into operation mode by pushing both navigation keys at the same time.
Parameterisation level		To confirm the changes made at the parameterization level.
	 	Adjustment of the value / the setting.
	 	Change into menu level or stop of the value input, by pushing both navigation keys at the same time.
Menu group level		Change to menu level
	 	Keys for up and down navigation in the menu group level.
	 	Change into operation mode or return into menu level, by pushing both navigation keys at the same time.

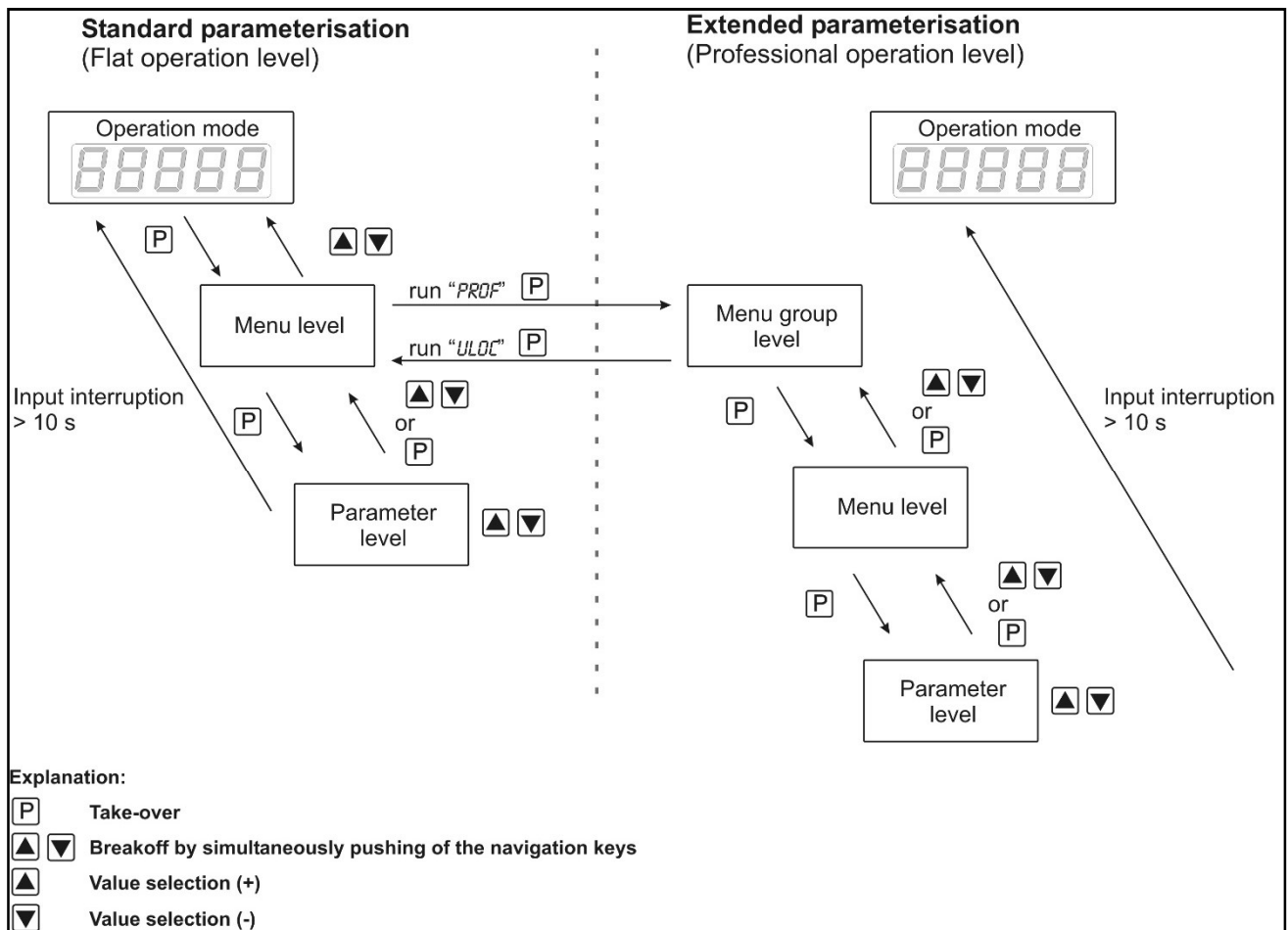
Function chart:**4.1 Parameterisation software PM-TOOL:**

Included in the delivery of the PM-TOOL are the software on CD and an USB-cable with device adapter. The connection happens via a 4-pole micromatch-plug on the back side of the device, to the PC-side the connection happens via an USB plug.

System requirements: PC incl. USB interface
Software: Windows XP, Windows VISTA

With this tool the device configuration can be generated, omitted and saved on the PC. The parameters can be changed via the easy to handle program surface, whereat the operating mode and the possible selection options can be preset by the program.

5. Setting up the device

5.1. Switching on







Once the installation is complete, start the device by applying the voltage supply. Before, check once again that all electrical connections are correct.



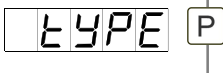
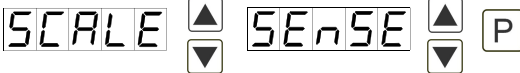
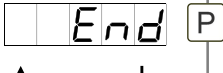

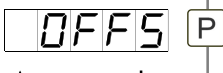

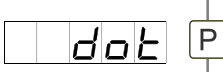

Starting sequence

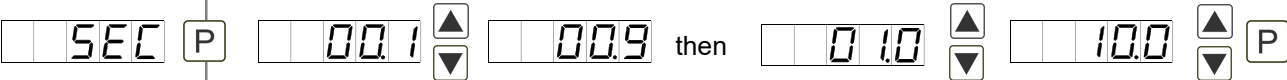
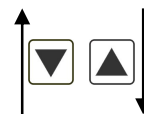
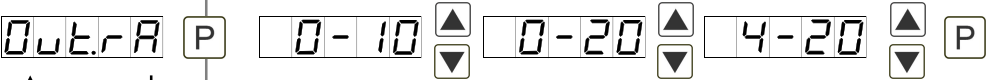
For 1 second during the switching-on process, the segment test (8 8 8 8 8) is displayed followed by an indication of the software type and, after that, also for 1 second the software version. After the starting sequence, the device switches to operation/display mode.

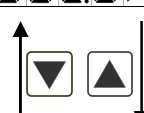

5.2. Standard parameterisation: (Flat operation level)

To parameterize the display, press the [P]-key in operating mode for 1 second. The display then changes to the menu level with the first menu item *TYPE*.

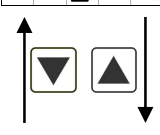
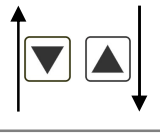
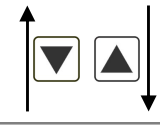
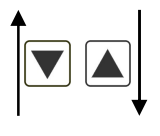
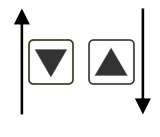

Menu level	Parameterisation level
	<p>Selection of the input signal, <i>TYPE</i>: Default: <i>SENS</i></p>  <p>Potentiometer values from >1 to <100kΩ are available as works calibration (without application of the sensor signal) and as sensor calibration (with applied measuring signal). Confirm the selection with [P] and the display switches back to menu level.</p>
	<p>Setting the end value of the measuring range, <i>END</i>: Default: <i>10000</i></p>  <p>Set the end value from the smallest to the highest digit with [▲] [▼] and confirm each digit with [P]. A minus sign can only be parameterized on the leftmost digit. After the last digit, the display switches back to the menu level. If <i>SENS</i> was selected as the input option, one can only select between <i>NOCA</i> and <i>CAL</i>. With <i>NOCA</i>, only the previously set display value is taken over, and with <i>CAL</i>, the device takes over both the display value and the analog input value.</p>
	<p>Setting the start/offset value of the measuring range, <i>OFFS</i>: Default: <i>0</i></p>  <p>Enter the start/offset value from the smallest to the highest digit [▲] [▼] and confirm each digit with [P]. After the last digit the display switches back to the menu level. If <i>SENS</i> was selected as the input option, one can only select between <i>NOCA</i> and <i>CAL</i>. With <i>NOCA</i>, only the previously set display value is taken over, and with <i>CAL</i>, the device takes over both the display value and the analog input value.</p>
	<p>Setting the decimal point, <i>DOT</i>: Default: <i>0</i></p>  <p>The decimal point on the display can be moved with [▲] [▼] and confirmed with [P]. The display then switches back to the menu level again.</p>

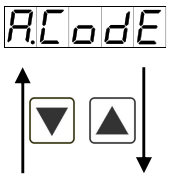
Menu level	Parameterisation level
	<p>Setting the display time, SEC: Default: 1.0</p> <p>  </p> <p>The display time is set with [▲] [▼]. The display moves up in increments of 0.1 up to 1 second and in increments of 1.0 to 10.0 seconds. Confirm the selection by pressing the [P] button. The display then switches back to the menu level again.</p>
	<p>Selection of analog output, OUT.RA: Default: 4-20</p> <p>  </p> <p>Available are 3 output signals: 0-10 VDC, 0-20 mA and 4-20 mA. With this function, the demanded signal is selected.</p>
	<p>Setting up the final value of the analog output, OUT.EN: Default: 10000</p> <p>  </p> <p>The final value is adjusted from the smallest digit to the highest digit with [▲] [▼] and digit by digit confirmed with [P]. A minus sign can only be parameterised on the leftmost digit. After the last digit, the device changes back into menu level.</p>
	<p>Setting up the initial value of the analog output, OUT.OF: Default: 00000</p> <p>  </p> <p>The final value is adjusted from the smallest digit to the highest digit with [▲] [▼] and digit by digit confirmed with [P]. A minus sign can only be parameterised on the leftmost digit. After the last digit, the device changes back into menu level.</p>
	<p>Threshold values / limits, LI-1: Default: 2000</p> <p>  </p> <p>This value defines the threshold, that activates/deactivates an alarm.</p>
	<p>Hysteresis for limit values, HY-1: Default: 00000</p> <p>  </p> <p>The delayed reaction of the alarm is the difference to the threshold value, which is defined by the hysteresis.</p>

Menu level	Parameterisation level
	<p>Function for threshold value undercut / exceedance, FU-1: Default: <i>HIGH</i></p> <p>FU-1 [P] HIGH [▲] [▼] LOWU [▲] [▼] [P]</p> <p>A limit value undercut is selected with <i>LOWU</i> (for LOW = lower limit value), a limit value exceedance with <i>HIGH</i> (for HIGH = higher limit value). If e.g. limit value 1 is on a threshold level of 100 and allocated with function <i>HIGH</i>, an alarm is activated by reaching the threshold level. If the threshold value was allocated to <i>LOW</i>, an alarm will be activated by undercutting the threshold value, as long as the hysteresis is zero.</p>
	<p>Threshold values / limits, LI-2: Default: <i>3000</i></p> <p>LI-2 [P] 0 [P] 0 [P] 0 [P] 0 [P] 0 [▲] [▼] [P]</p> <p>This value defines the threshold, that activates/deactivates an alarm.</p>
	<p>Hysteresis for limit values, HY-2: Default: <i>00000</i></p> <p>HY-2 [P] 0 [P] 0 [P] 0 [P] 0 [P] 0 [▲] [▼] [P]</p> <p>The delayed reaction of the alarm is the difference to the threshold value, which is defined by the hysteresis.</p>
	<p>Function for threshold value undercut / exceedance, FU-2: Default: <i>HIGH</i></p> <p>FU-2 [P] HIGH [▲] [▼] LOWU [▲] [▼] [P]</p> <p>A limit value undercut is selected with <i>LOWU</i> (for LOW = lower limit value), a limit value exceedance with <i>HIGH</i> (for HIGH = higher limit value). If e.g. limit value 1 is on a threshold level of 100 and allocated with function <i>HIGH</i>, an alarm is activated by reaching the threshold level. If the threshold value was allocated to <i>LOW</i>, an alarm will be activated by undercutting the threshold value, as long as the hysteresis is zero.</p>
	<p>User code (4-digit number-combination, free available), U.CODE: Default: <i>0000</i></p> <p>U.CoDE [P] 8 [P] 8 [P] 8 [P] 8 [▲] [▼] [P]</p> <p>If this code was set (>0000), all parameters are locked for the user, if <i>LOC</i> has been selected before under menu item <i>RUN</i>. By pressing [P] for 3 seconds in operation mode, the display shows <i>CODE</i>. The <i>U.CODE</i> needs to be entered to get to the reduced number of parameter sets. The code has to be entered before each parameterisation, until the <i>R.CODE</i> (Master code) releases all parameters again.</p>

Menu level	Parameterisation level
	<p>Master code (4-digit number-combination, free available), A.CODE: Default: 1234</p>  <p>All parameters can be released with this code, after <i>LOC</i> has been activated under menu item <i>RUN</i>. By pressing [P] for 3 seconds in operation mode, the display shows <i>CODE</i> and enables the user to reach all parameters by entering the <i>A.CODE</i>. Under <i>RUN</i> the parameterisation can be activated permanently by selecting <i>ULOC</i> or <i>PROF</i>, thus at an anew pushing of [P] in operation mode, the code needs not to be entered again.</p>

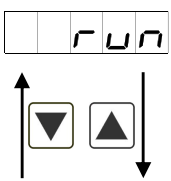
5.3. Programming interlock „RUN“







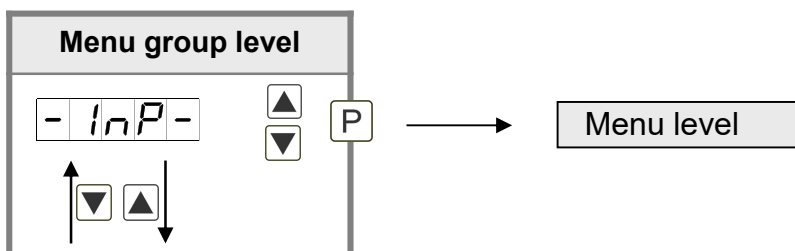

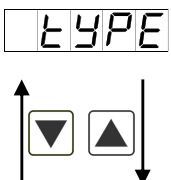
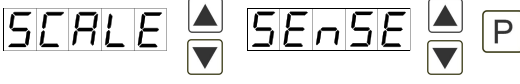
	<p>Activation / deactivation of the programming lock or completion of the standard parameterization with change into menu group level (complete function range), RUN: Default: <i>ULOC</i></p>  <p>With the navigation keys [▲] [▼], choose between the deactivated key lock <i>ULOC</i> (works setting) and the activated key lock <i>LOC</i>, or the change into the menu group level <i>PROF</i>. Confirm the selection with [P]. After this, the display confirms the settings with "- - - -" and automatically switches to operating mode. If <i>LOC</i> was selected, the keyboard is locked. To get back into the menu level, press [P] for 3 seconds in operating mode, enter the <i>CODE</i> (works setting 1 2 3 4) that appears using [▲] [▼] plus [P] to unlock the keyboard. <i>FAIL</i> appears if the input was wrong. To parameterize further functions <i>PROF</i> needs to be set. The device confirms this setting with showing „- - - -“, and changes automatically in operation mode. By pressing [P] for approx. 3 seconds in operation mode, the first menu group <i>IMP</i> is shown in the display and thus confirms the change into the extended parameterisation. It stays activated as long as <i>ULOC</i> or <i>LOC</i> were entered in menu group <i>RUN</i>.</p>
---	--

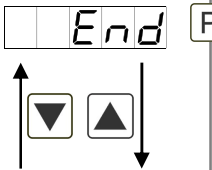

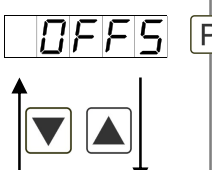

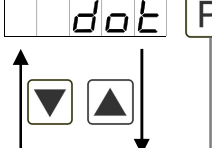
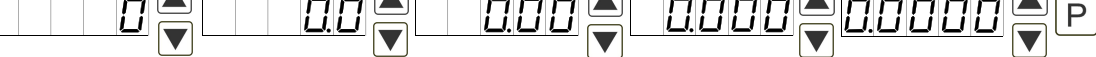
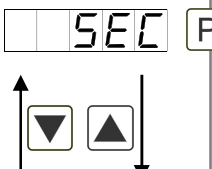
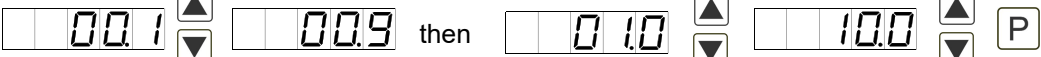
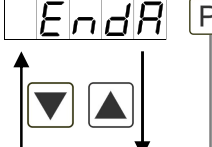





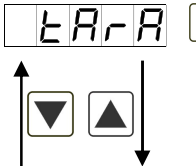

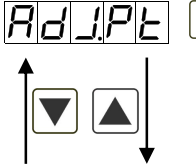
5.4. Extended parameterisation (Professional operation level)

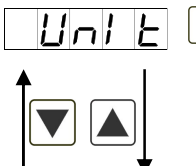
5.4.1. Signal input parameters

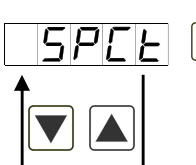

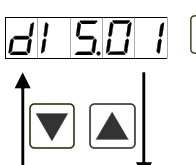
Menu level	Parameterization level
	<p>Selection of the input signal, TYPE: Default: <i>SENS</i></p>  <p>Potentiometer values from >1 to <1000 kΩ are available as works calibration (without application of the sensor signal) and as sensor calibration (with applied measuring signal). Confirm the selection with [P] and the display switches back to menu level.</p>

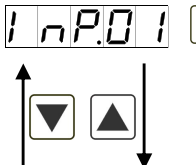
Menu level	Parameterisation level
	<p>Setting the end value of the measuring range, <i>END</i>: Default: 10000</p>  <p>Set the end value from the smallest to the highest digit with [▲] [▼] and confirm each digit with [P]. A minus sign can only be parameterized on the leftmost digit. After the last digit, the display switches back to the menu level. If <i>SENS</i> was selected as input option, one can only select between <i>NOCA</i> and <i>CAL</i>. With <i>NOCA</i>, only the previously set display value is taken over, and with <i>CAL</i>, the device takes over both the display value and the analog input value.</p>
	<p>Setting the start/offset value of the measuring range, <i>OFFS</i>: Default: 0</p>  <p>Enter the start/offset value from the smallest to the highest digit [▲] [▼] and confirm each digit with [P]. After the last digit the display switches back to the menu level. If <i>SENS</i> was selected as input option, one can only select between <i>NOCA</i> and <i>CAL</i>. With <i>NOCA</i>, only the previously set display value is taken over, and with <i>CAL</i>, the device takes over both the display value and the analog input value.</p>
	<p>Setting the decimal point, <i>DOT</i>: Default: 0</p>  <p>The decimal point on the display can be moved with [▲] [▼] and confirmed with [P]. The display then switches back to the menu level again.</p>
	<p>Setting up the display time, <i>SEC</i>: Default: 1.0</p>  <p>The display time is set with [▲] [▼]. The display moves up in increments of 0.1 up to 1 second and in increments of 1.0 up to 10.0 seconds. Confirm the selection by pressing the [P] button. The display then switches back to the menu level again.</p>
	<p>Rescaling the measuring input values, <i>ENDA</i>: Default: 10000</p>  <p>With this function, rescale the input value of e.g. 100 kΩ (works setting) without applying a measuring signal. If sensor calibration has been selected, these parameters are not available.</p>
	<p>Rescaling the measuring input values, <i>OFFSA</i>: Default: 0</p>  <p>With this function, rescale the input value of e.g. 1,5 kΩ (works setting) without applying a measuring signal. If sensor calibration has been selected, these parameters are not available.</p>



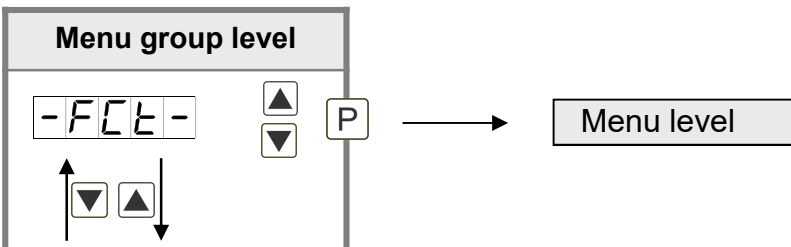

Menu level	Parameterisation level
	<p>Setting up the tare/offset value, <i>TARA</i>: Default: 0</p>  <p>The given value is added to the linearized value. In this way, the characteristic line can be shifted by the selected amount.</p>
	<p>Setting up the balance point, <i>ADJ.PT</i>: Default: 08000</p>  <p>The balance point for the final value can be chosen from the measuring range by <i>SENSE</i>. The preset 80.000% result from the widespread detuning of the melt pressure sensors.</p>
	<p>Setting up the physical unit, <i>UNIT</i>: Default: <i>NO</i></p>  <p>One can choose between the above shown physical units. It will be displayed on the 5th digit of the display.</p>
	<p>Number of additional setpoints, <i>SPCT</i>: Default: 00</p>  <p>30 additional setpoints can be defined to the initial value and final value, so linear sensor values are not linearised. Only activated setpoint parameters are displayed.</p>
	<p>Display values for setpoints, <i>DIS.01 ... DIS.30</i>:</p>  <p>Under this parameter setpoints are defined according to their value. At the sensor calibration, like at final value/offset, one is asked at the end if a calibration shall be activated.</p>
	<p>Analog values for setpoints, <i>INP.01 ... INP.30</i>:</p>  <p>The setpoints are always set according to the selected input signal. The desired analog values can be freely parameterised in ascending order.</p>

Menu level	Parameterisation level
	<p>Device undercut, <i>DI.UND</i>: Default: -19999</p> <p>With this function the device undercut (_____) can be defined on a definite value. Exception is input type 4-20 mA, it already shows undercut at a signal <1 mA, so a sensor failure is marked.</p>
	<p>Display overflow, <i>DI.OUE</i>: Default: 99999</p> <p>With this function the display overflow (-----) can be defined on a definite value.</p>
	<p>Back to menu group level, <i>RET</i>:</p> <p>With [P] the selection is confirmed and the device changes into menu group level „-INP-“.</p>



5.4.2. General device parameters

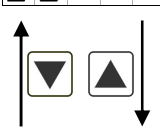
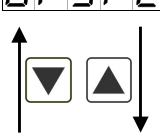
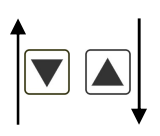
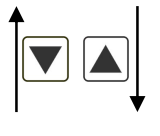

Menu level	Parameterization level
	<p>Display time, <i>DISEC</i>: Default: 01.0</p> <p>The display is set up with [▲] [▼]. Thereby it switches until 1 second in increments of 0.1 seconds and until 10.0 seconds in increments of 1.0. With [P] the selection is confirmed and the device changes into menu level.</p>
	<p>Rounding of display values, <i>ROUND</i>: Default: 00001</p> <p>This function is for instable display values, where the display value is changed in increments of 1, 5, 10 or 50. This does not affect the resolution of the optional outputs. With [P] the selection is confirmed and the device changes into menu level.</p>

Menu level	Parameterisation level
	<p>Arithmetic, ARITH: Default: <i>NO</i></p> <p>ArITH P no rEZIP rADiC SqUAR P</p> <p style="text-align: center;">Reciprocal value Square root Square</p> <p>With this function the calculated value, not the measuring value, is shown in the display. Calculation types rEZIP = (Final value*Final value)/Display value rAdiC = Root(Display value*Final value) SqUAR = (Display value)²/Final value</p> <p>Advice: The denominator of fractions should not be 0 because a division by 0 is not possible. It creates an undefined state and the display goes into the overflow. With <i>NO</i>, no calculation is deposited. With [P] the selection is confirmed and the device changes into menu level.</p>
	<p>Sliding average determination, AVG: Default: <i>10</i></p> <p>AUG P 01 50 P</p> <p>Under this menu item, the number of measurements that need to be averaged are preset. The averaging time results from the product of measuring time <i>SEC</i> and the averaged measurements <i>AVG</i>. With selection of <i>AVG</i> in menu level <i>DISPL</i> the result is shown in the display and evaluated when entered in the alarm <i>ALI-AL4</i> or the analog output <i>OUTPT</i>.</p>
	<p>Zero point slowdown, ZERO: Default: <i>00</i></p> <p>ZEr0 P 0 P 0 P</p> <p>At the zero point slowdown, a value range around the zero point can be preset, so the display shows a zero. If e.g. 10 is set, the display would show a 0 in the value range from -10 to +10; below continue with -11 and beyond with +11. The maximum adjustable range of value is 99.</p>
	<p>Solid constant value, CONST: Default: <i>0</i></p> <p>const P 8 P 8 P 8 P 8 P 8 P</p> <p>The constant value can be evaluated like the current measurand via the alarms or the analog output. The decimal place cannot be changed for this value and is taken over from the current measurand. So, with this value a setpoint generator can be realised via the analog output. Furthermore it can be used as calculated difference. At this the constant value needs to be subtracted from the current measurand and the difference is evaluated in the alerting or via the analog output. Thus regulation can be displayed quite easy with this parameterisation.</p>
	<p>Minimum constant value, COM.MI: Default: <i>-19999</i></p> <p>conMI P 8 P 8 P 8 P 8 P 8 P</p> <p>The minimum constant value is selected and adjusted from the smallest to the highest digit with [▲] [▼] and confirmed digit per digit with [P]. A minus sign can only be adjusted on the leftmost digit. After the last digit the display changes back into menu level.</p>



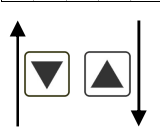
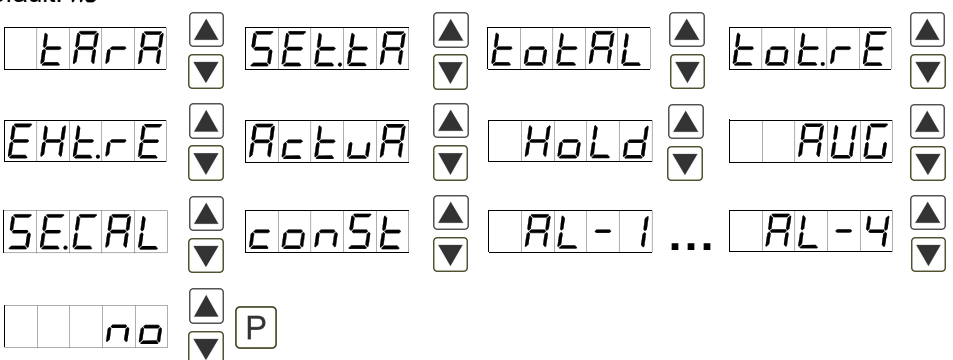
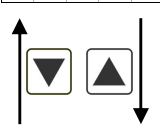

Menu level	Parameterisation level
	<p>Maximum constant value, <i>CON.MA</i>: Default: 99999</p> <p><i>conMA</i> [P] 8 [P] 8 [P] 8 [P] 8 [P] 8 [▲▼] [P]</p> <p>The maximum constant value is selected and adjusted from the smallest to the highest digit with [▲] [▼] and confirmed digit per digit with [P]. A minus sign can only be adjusted on the leftmost digit. After the last digit the display changes back into menu level.</p>
	<p>Display, <i>DISPL</i>: Default: ACTUA</p> <p><i>diSPL</i> [P] ActUA [▲▼] miNUA [▲▼] MAXUA [▲▼] totAL [▲▼] HoLD [▲▼] AUG [▲▼] const [▲▼] dIFF [▲▼] [P]</p> <p>With this function the current measurand, the min/max-value, the totaliser, the process-controlled hold-value, the sliding average value, the constant value or the difference between constant value and current value can be allocated to the display. With [P] the selection is confirmed and the device changes into menu level.</p>
	<p>Brightness control, <i>LIGHT</i>: Default: 15</p> <p><i>LIGHt</i> [P] 00 [▲▼] 15 [▲▼] [P]</p> <p>The brightness of the display can be adjusted in 16 levels from 00 = very dark to 15 = very bright via this parameter or alternatively via the navigation keys from the outside. During the start of the device the level that is deposited under this parameter will always be used, even though the brightness has been changed via the navigation keys in the meantime.</p>
	<p>Display flashing, <i>FLASH</i>: Default: NO</p> <p><i>FLASH</i> [P] no [▲▼] AL-1 [▲▼] AL-2 [▲▼] AL.12 [▲▼] AL-3 [▲▼] AL-4 [▲▼] AL.34 [▲▼] ALAL [▲▼] [P]</p> <p>A display flashing can be added as additional alarm function either to single or to a combination of off-limit condition. With <i>NO</i>, no flashing is allocated.</p>

Menu level	Parameterisation level																																
<div style="display: flex; align-items: center;"> <div style="border: 1px solid black; padding: 2px; margin-right: 5px;">tAST</div> <div style="border: 1px solid black; border-radius: 50%; padding: 2px 5px; margin-right: 5px;">P</div> <div style="margin-right: 10px;">  </div> </div>	<p>Assignment (deposit) of key functions, TAST:</p> <p>Default: <i>NO</i></p> <table style="width: 100%; border-collapse: collapse;"> <tr> <td style="border: 1px solid black; padding: 2px;">EHTR</td><td style="text-align: center;">▲ ▼</td> <td style="border: 1px solid black; padding: 2px;">LI.12</td><td style="text-align: center;">▲ ▼</td> <td style="border: 1px solid black; padding: 2px;">LI.34</td><td style="text-align: center;">▲ ▼</td> <td style="border: 1px solid black; padding: 2px;">TARA</td><td style="text-align: center;">▲ ▼</td> </tr> <tr> <td style="border: 1px solid black; padding: 2px;">SETTA</td><td style="text-align: center;">▲ ▼</td> <td style="border: 1px solid black; padding: 2px;">TOTAL</td><td style="text-align: center;">▲ ▼</td> <td style="border: 1px solid black; padding: 2px;">TOT.RE</td><td style="text-align: center;">▲ ▼</td> <td style="border: 1px solid black; padding: 2px;">EHT.RE</td><td style="text-align: center;">▲ ▼</td> </tr> <tr> <td style="border: 1px solid black; padding: 2px;">ACTUA</td><td style="text-align: center;">▲ ▼</td> <td style="border: 1px solid black; padding: 2px;">LIGHT</td><td style="text-align: center;">▲ ▼</td> <td style="border: 1px solid black; padding: 2px;">L11</td><td style="text-align: center;">▲ ▼</td> <td style="border: 1px solid black; padding: 2px;">L11-2</td><td style="text-align: center;">▲ ▼</td> </tr> <tr> <td style="border: 1px solid black; padding: 2px;">L11-3</td><td style="text-align: center;">▲ ▼</td> <td style="border: 1px solid black; padding: 2px;">L11-4</td><td style="text-align: center;">▲ ▼</td> <td style="border: 1px solid black; padding: 2px;">no</td><td style="text-align: center;">▲ ▼</td> <td style="border: 1px solid black; border-radius: 50%; padding: 2px 5px;">P</td><td></td> </tr> </table> <p>For the operation mode, special functions can be deposited on the navigation keys [▲] [▼], in particular this function is made for devices in housing size 48x24mm which do not have a 4th key ([O]-key). If the min/max-memory is activated with <i>EHTR</i>, all measured min/max-values are saved during operation and can be recalled via the navigation keys. The values get lost by re-start of the device. If the threshold value correction <i>LI.12</i> or <i>LI.34</i> were chosen, the values of the threshold can be changed during operation without disturbing the operating procedure. With <i>TARA</i> the device is set temporarily on a parameterised value. The device acknowledges the correct taring with <i>00000</i>. <i>SET.TA</i> switches into the offset value and can be adjusted via the navigation keys. Via <i>TOTAL</i> the current value of the totaliser can be displayed for approx. 7 sec, after this the device switches back on the parameterised display value. If <i>TOT.RE</i> is deposited, the totaliser can be set back by pressing of the navigation keys [▲] [▼], the device acknowledges this with showing <i>00000</i>. By allocation on <i>EHT.RE</i> the min/max-memory is deleted. At <i>ACTUA</i> the measurand is shown for approx. 7 sec, after this the device switches back on the parameterised display value. With <i>LIGHT</i> the brightness of the display is adjusted. This setting is not saved and gets lost at a restart fo the device. Via selection <i>L1.1</i>, <i>L1.1-2</i>, <i>L1.1-3</i>, <i>L1.1-4</i> threshold values can be addressed via the navigation keys; they can be changed digit per digit or taken over by pushing the [P]-key. The adjustment is taken over directly, an existing limit value monitoring and the current measurement will not be influenced by this. If <i>NO</i> was selected, the navigation keys are without any function in the operation mode.</p>	EHTR	▲ ▼	LI.12	▲ ▼	LI.34	▲ ▼	TARA	▲ ▼	SETTA	▲ ▼	TOTAL	▲ ▼	TOT.RE	▲ ▼	EHT.RE	▲ ▼	ACTUA	▲ ▼	LIGHT	▲ ▼	L11	▲ ▼	L11-2	▲ ▼	L11-3	▲ ▼	L11-4	▲ ▼	no	▲ ▼	P	
EHTR	▲ ▼	LI.12	▲ ▼	LI.34	▲ ▼	TARA	▲ ▼																										
SETTA	▲ ▼	TOTAL	▲ ▼	TOT.RE	▲ ▼	EHT.RE	▲ ▼																										
ACTUA	▲ ▼	LIGHT	▲ ▼	L11	▲ ▼	L11-2	▲ ▼																										
L11-3	▲ ▼	L11-4	▲ ▼	no	▲ ▼	P																											
<div style="display: flex; align-items: center;"> <div style="border: 1px solid black; padding: 2px; margin-right: 5px;">di GIn</div> <div style="border: 1px solid black; border-radius: 50%; padding: 2px 5px; margin-right: 5px;">P</div> <div style="margin-right: 10px;">  </div> </div>	<p>Special function digital input, DIG.IN:</p> <p>Default: <i>NO</i></p> <table style="width: 100%; border-collapse: collapse;"> <tr> <td style="border: 1px solid black; padding: 2px;">TARA</td><td style="text-align: center;">▲ ▼</td> <td style="border: 1px solid black; padding: 2px;">SETTA</td><td style="text-align: center;">▲ ▼</td> <td style="border: 1px solid black; padding: 2px;">TOTAL</td><td style="text-align: center;">▲ ▼</td> <td style="border: 1px solid black; padding: 2px;">TOT.RE</td><td style="text-align: center;">▲ ▼</td> </tr> <tr> <td style="border: 1px solid black; padding: 2px;">EHT.RE</td><td style="text-align: center;">▲ ▼</td> <td style="border: 1px solid black; padding: 2px;">ACTUA</td><td style="text-align: center;">▲ ▼</td> <td style="border: 1px solid black; padding: 2px;">HOLD</td><td style="text-align: center;">▲ ▼</td> <td style="border: 1px solid black; padding: 2px;">AVG</td><td style="text-align: center;">▲ ▼</td> </tr> <tr> <td style="border: 1px solid black; padding: 2px;">SECAL</td><td style="text-align: center;">▲ ▼</td> <td style="border: 1px solid black; padding: 2px;">const</td><td style="text-align: center;">▲ ▼</td> <td style="border: 1px solid black; padding: 2px;">AL-1 ...</td><td style="text-align: center;">▲ ▼</td> <td style="border: 1px solid black; padding: 2px;">AL-4</td><td style="text-align: center;">▲ ▼</td> </tr> <tr> <td style="border: 1px solid black; padding: 2px;">no</td><td style="text-align: center;">▲ ▼</td> <td style="border: 1px solid black; border-radius: 50%; padding: 2px 5px;">P</td><td></td><td></td><td></td><td></td><td></td> </tr> </table> <p>For operating mode, special functions can be realised via the digital input. This function is actuated by keypress. With <i>TARA</i> the device is tared to zero and saved permanently as offset. The display acknowledges this with showing <i>00000</i>. <i>SET.TA</i> switches into the offset value and can be changed via the navigation keys. Via <i>TOTAL</i> the current value of the totaliser can be displayed for approx. 7 sec, then the device switches back on the parameterised display value. If <i>TOT.RE</i> is deposited, the totaliser can be set back by pressing the navigation keys, the device acknowledges this with showing <i>00000</i>. <i>EHT.RE</i> deletes the min/max-memory. If <i>HOLD</i> has been selected, the moment can be hold constant by triggering the digital input, and is updated by releasing the key. Advice: <i>HOLD</i> can only be activated, if <i>HOLD</i> was selected under parameter <i>DISPL</i>. <i>ACTUA</i> shows the measurand for approx. 7 sec, after this the device switches back on the parameterised display value. The same applies to <i>AVG</i>, here the sliding average value is displayed.</p>	TARA	▲ ▼	SETTA	▲ ▼	TOTAL	▲ ▼	TOT.RE	▲ ▼	EHT.RE	▲ ▼	ACTUA	▲ ▼	HOLD	▲ ▼	AVG	▲ ▼	SECAL	▲ ▼	const	▲ ▼	AL-1 ...	▲ ▼	AL-4	▲ ▼	no	▲ ▼	P					
TARA	▲ ▼	SETTA	▲ ▼	TOTAL	▲ ▼	TOT.RE	▲ ▼																										
EHT.RE	▲ ▼	ACTUA	▲ ▼	HOLD	▲ ▼	AVG	▲ ▼																										
SECAL	▲ ▼	const	▲ ▼	AL-1 ...	▲ ▼	AL-4	▲ ▼																										
no	▲ ▼	P																															

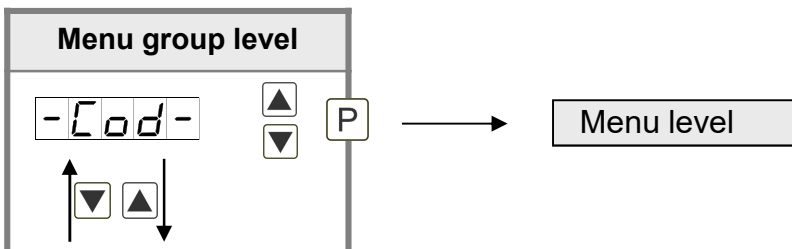
Menu level	Parameterisation level
<p>Continuation</p> 	<p>Special function digital input, DIG.IN: Default: <i>NO</i></p> <p>  </p> <p>A sensor calibration is done by triggering of the digital input via <i>SE.CAL</i>, the flow diagram is shown in <i>Chapter 8</i>. The constant value <i>CONST</i> can be recalled via the digital input, or changed digit per digit. At <i>AL-1...AL-4</i> there can be set an output and therewith e.g. a setpoint adjustment can be done. If <i>NO</i> was selected, the digital input is without any function in the operation mode.</p>
	<p>Back to menu group level, RET:</p> <p>With [P] the selection is confirmed and the device changes into menu group level „-FCT-“.</p>

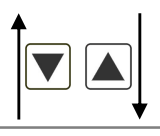
5.4.3. Safety parameters

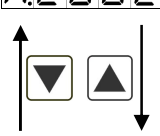







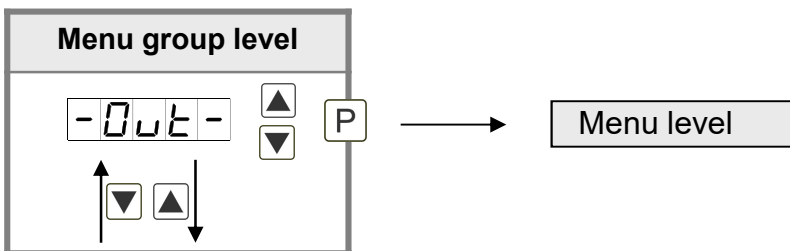

Menu level	Parameterisation level
	<p>User code U.CODE: Default: <i>0000</i></p> <p>  </p> <p>Via this code, reduced sets of parameters can be released. A change of the <i>U.CODE</i> can be done via the correct input of the <i>A.CODE</i> (master code).</p>
	<p>Master code, A.CODE: Default: <i>1234</i></p> <p>  </p> <p>By entering <i>A.CODE</i> the device will be unlocked and all parameters are released.</p>

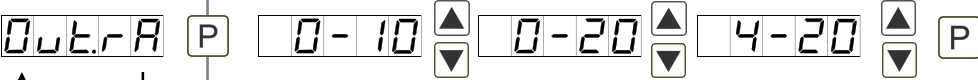
Menu level	Parameterisation level
	<p>Release/lock analog output parameters, <i>OUT.LE</i>: Default: <i>ALL</i></p> <p>OUT.LE P [] no [▲] [▼] EN-OF [▲] [▼] OUT.ED [▲] [▼] [] ALL [▲] [▼] P</p> <p>Analog output parameters can be locked or released for the user:</p> <ul style="list-style-type: none"> - <i>EN-OF</i>: the initial or final value can be changed in operation mode - <i>OUT.ED</i>: the output signal can be changed from e.g. 0-20 mA to 4-20 mA or 0-10 VDC - <i>ALL</i>: analog output parameters are released - <i>NO</i>: all analog output parameters are locked
	<p>Release/lock alarm parameters, <i>AL.LEU</i>: Default: <i>ALL</i></p> <p>AL.LEU P [] no [▲] [▼] LIMIT [▲] [▼] ALRM.L [▲] [▼] [] ALL [▲] [▼] P</p> <p>This parameter describes the user release/user lock of the alarm:</p> <ul style="list-style-type: none"> - <i>LIMIT</i>: here only the range of value of the threshold values 1-4 can be changed - <i>ALRM.L</i>: here the range of value and the alarm trigger can be changed - <i>ALL</i>: all alarm parameters are released - <i>NO</i>: all alarm parameters are locked
	<p>Back to menu group level, <i>RET</i>:</p> <p>With [P] the selection is confirmed and the device changes into menu group level „-COD-“.</p>

5.4.4. Analog output parameters



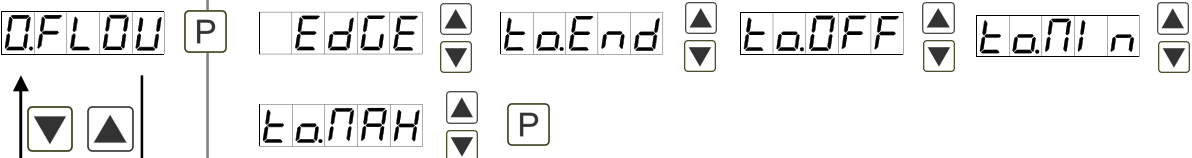

Menu level	Parameterisation level
	<p>Selection reference analog output, <i>OUTPT</i>: Default: <i>ACTUR</i></p> <p>OUTPT P Actur [▲] [▼] MinVal [▲] [▼] MAXVAL [▲] [▼] total [▲] [▼] Hold [▲] [▼] [] AVG [▲] [▼] const [▲] [▼] diff [▲] [▼] P</p> <p>The analog output signal can refer to different functions, in detail this are the current measurand, min/max-value or totaliser function / sum-function, the sliding average value, the constant value or the difference between the current value and the constant value. If <i>HOLD</i> was selected the signal of the analog output will be hold and processed just after deactivation of <i>HOLD</i>. With [P] the selection is confirmed and the device changes into menu level.</p>

Menu level	Parameterisation level
	<p>Selection analog output, <i>OUT.RA</i>: Default: 4-20</p> <p>  </p> <p>Available are 3 output signals: 0-10 VDC, 0-20 mA and 4-20 mA. With this function the demanded signal can be selected.</p>
	<p>Setting up the final value of the analog output, <i>OUT.EN</i>: Default: 10000</p> <p>  </p> <p>The final value can be adjusted from the smallest to the largest digit with [▲] [▼]. Confirm each digit with [P]. A minus sign can only be parameterized on the leftmost digit. After the last digit, the display switches back to the menu level.</p>
	<p>Setting the initial value of the analog output, <i>OUT.OF</i>: Default: 00000</p> <p>  </p> <p>The initial value is adjusted from the smallest to the highest digit with [▲] [▼] and confirmed digit per digit with [P]. A minus sign can only be parameterized on the leftmost digit. After the last digit the device changes back into menu level.</p>
	<p>Overflow behaviour, <i>O.FLOW</i>: Default: <i>EDGE</i></p> <p>  </p> <p>To recognise and evaluate faulty signals, e.g. by a controller, the overflow behaviour of the analog output can be defined. As overflow can be seen either <i>EDGE</i>, that means the analog output runs on the set limits e.g. 4 and 20 mA, or <i>TO.OFF</i> (input value smaller than initial value, analog output switches on e.g. 4 mA), <i>TO.END</i> (higher than final value, analog output switches on e.g. 20 mA). If <i>TO.MIN</i> or <i>TO.MAX</i> is set, the analog output switches on the least significant or leftmost possible binary value. This means that values of e.g. 0 mA, 0 VDC or values higher than 20 mA or 10 VDC can be reached. With [P] the selection is confirmed and the device changes into menu level.</p>
	<p>Back to menu group level, <i>RET</i>:</p> <p>With [P] the selection is confirmed and the device changes into menu group level „-OUT-“.</p>

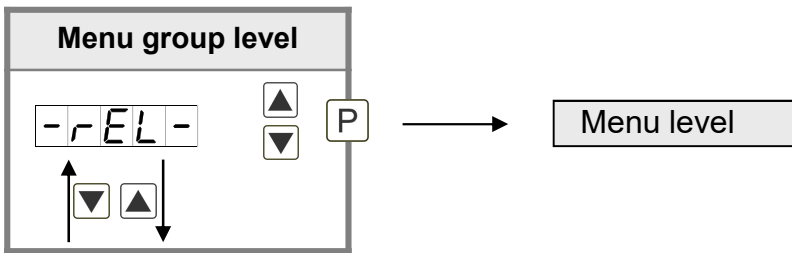
5.4.5. Relay functions



Menu level	Parameterization level												
	<p>Alarm relay 1, REL-1: Default: AL-1</p> <p>REL-1 P AL-1 AL-4 AL-n1 AL-n4</p> <p>LOGIC OFF On CAL</p> <p>CALOF CALEN P</p> <p>Each setpoint (optional) can be linked up via 4 alarms (by default). This can either be inserted at activated alarms AL1/4 or deactivated alarms ALN1/4. If LOGIC was selected, logical links are available in the menu level LOG-1 and COM-1. Access to these two menu levels is via LOGIC, at all other selected functions, these two parameters are overleaped. Via ON/OFF the setpoints can be activated/deactivated, in this case the output and the setpoint display are set/not set on the front of the device. The parameters CAL, CAL.OF and CAL.EN can only be used in accordance with the semi-automatic calibration (Chapter 8. Sensor alignment). At CAL the relay switches during sensor calibration, at CAL.OF during offset calibration and at CAL.EN during the calibration of the final value. With [P] the selection is confirmed and the device changes into menu level.</p>												
	<p>Logic relay 1, LOG-1 Default: OR</p> <p>LOG-1 P or nor And nAnd P</p> <p>The switching behaviour of the relay is defined via a logic link, the following schema describes these functions with inclusion of AL-1 and AL-2. This parameter can only be selected if LOGIC was selected under REL-1.</p> <table border="1"> <tbody> <tr> <td>or</td> <td>$A1 \vee A2$</td> <td>As soon as a selected alarm is activated, the relay operates. Equates to operating current principle.</td> </tr> <tr> <td>nor</td> <td>$\overline{A1 \vee A2} = \overline{A1} \wedge \overline{A2}$</td> <td>The relay operates only, if no selected alarm is active. Equates to quiescent current principle.</td> </tr> <tr> <td>And</td> <td>$A1 \wedge a2$</td> <td>The relay operates only, if all selected alarms are active.</td> </tr> <tr> <td>nAnd</td> <td>$\overline{A1 \wedge A2} = \overline{A1} \vee \overline{A2}$</td> <td>As soon as a selected alarm is not activated, the relay operates.</td> </tr> </tbody> </table> <p>With [P] the selection is confirmed and the device changes into menu level.</p>	or	$A1 \vee A2$	As soon as a selected alarm is activated, the relay operates. Equates to operating current principle.	nor	$\overline{A1 \vee A2} = \overline{A1} \wedge \overline{A2}$	The relay operates only, if no selected alarm is active. Equates to quiescent current principle.	And	$A1 \wedge a2$	The relay operates only, if all selected alarms are active.	nAnd	$\overline{A1 \wedge A2} = \overline{A1} \vee \overline{A2}$	As soon as a selected alarm is not activated, the relay operates.
or	$A1 \vee A2$	As soon as a selected alarm is activated, the relay operates. Equates to operating current principle.											
nor	$\overline{A1 \vee A2} = \overline{A1} \wedge \overline{A2}$	The relay operates only, if no selected alarm is active. Equates to quiescent current principle.											
And	$A1 \wedge a2$	The relay operates only, if all selected alarms are active.											
nAnd	$\overline{A1 \wedge A2} = \overline{A1} \vee \overline{A2}$	As soon as a selected alarm is not activated, the relay operates.											

Menu level	Parameterisation level												
	<p>Alarms for relay 1, COM-1: Default: <i>A.1</i></p> <p>COM-1 [P] A.1 [▲] [▼] A.2 [▲] [▼] ... A.1234 [▲] [▼] [P]</p> <p>The allocation of the alarms to relay 1 happens via this parameter, one alarm or a group of alarms can be chosen. With [P] the selection is confirmed and the device changes into menu level.</p>												
	<p>Alarm relay 2, REL-2: Default: <i>AL-2</i></p> <p>REL-2 [P] AL-5 [▲] [▼] ... AL-8 [▲] [▼] AL-n5 [▲] [▼] ... AL-n8 [▲] [▼]</p> <p>LOGIC [▲] [▼] OFF [▲] [▼] On [▲] [▼] CAL [▲] [▼]</p> <p>CAL.OF [▲] [▼] CAL.EN [▲] [▼] [P]</p> <p>Each setpoint (optional) can be linked up via 4 alarms (by default). This can either be inserted at activated alarms <i>AL1/4</i> or deactivated alarms <i>ALN1/4</i>. If <i>LOGIC</i> was selected, logical links are available in the menu level <i>LOG-1</i> and <i>COM-1</i>. Access to these two menu levels is via <i>LOGIC</i>, at all other selected functions, these two parameters are overleaped. Via <i>ON/OFF</i> the setpoints can be activated/deactivated, in this case the output and the setpoint display are set/not set on the front of the device. The parameters <i>CAL</i>, <i>CAL.OF</i> and <i>CAL.EN</i> can only be used in accordance with the semi-automatic calibration (<i>Chapter 8. Sensor alignment</i>). At <i>CAL</i> the relay switches during sensor calibration, at <i>CAL.OF</i> during offset calibration and at <i>CAL.EN</i> during the calibration of the final value. With [P] the selection is confirmed and the device changes into menu level.</p>												
	<p>Logic relay 2, LOG-2: Default: <i>OR</i></p> <p>LOG-2 [P] or [▲] [▼] nor [▲] [▼] And [▲] [▼] nAnd [▲] [▼] [P]</p> <p>The switching behaviour of the relay is defined via a logic link, the following schema describes these functions with inclusion of <i>AL-1</i> and <i>AL-2</i>. This parameter can only be selected if <i>LOGIC</i> was selected under <i>REL-1</i>.</p> <table border="1"> <tbody> <tr> <td>or</td> <td>$A1 \vee A2$</td> <td>As soon as a selected alarm is activated, the relay operates. Equates to operating current principle.</td> </tr> <tr> <td>nor</td> <td>$\overline{A1 \vee A2} = \overline{A1} \wedge \overline{A2}$</td> <td>The relay operates only, if no selected alarm is active. Equates to quiescent current principle.</td> </tr> <tr> <td>And</td> <td>$A1 \wedge A2$</td> <td>The relay operates only, if all selected alarms are active.</td> </tr> <tr> <td>nAnd</td> <td>$\overline{A1 \wedge A2} = \overline{A1} \vee \overline{A2}$</td> <td>As soon as a selected alarm is not activated, the relay operates.</td> </tr> </tbody> </table> <p>With [P] the selection is confirmed and the device changes into menu level.</p>	or	$A1 \vee A2$	As soon as a selected alarm is activated, the relay operates. Equates to operating current principle.	nor	$\overline{A1 \vee A2} = \overline{A1} \wedge \overline{A2}$	The relay operates only, if no selected alarm is active. Equates to quiescent current principle.	And	$A1 \wedge A2$	The relay operates only, if all selected alarms are active.	nAnd	$\overline{A1 \wedge A2} = \overline{A1} \vee \overline{A2}$	As soon as a selected alarm is not activated, the relay operates.
or	$A1 \vee A2$	As soon as a selected alarm is activated, the relay operates. Equates to operating current principle.											
nor	$\overline{A1 \vee A2} = \overline{A1} \wedge \overline{A2}$	The relay operates only, if no selected alarm is active. Equates to quiescent current principle.											
And	$A1 \wedge A2$	The relay operates only, if all selected alarms are active.											
nAnd	$\overline{A1 \wedge A2} = \overline{A1} \vee \overline{A2}$	As soon as a selected alarm is not activated, the relay operates.											

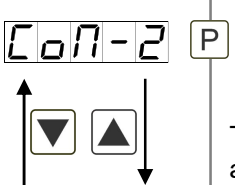
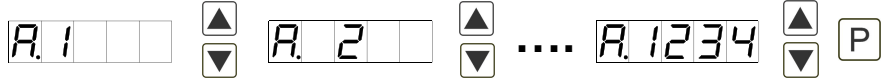
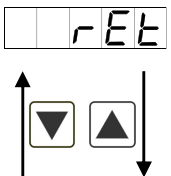
Menu level	Parameterisation level
	<p>Alarms for relay 2, CON-2: Default: A. 2</p>  <p>The allocation of the alarms to relay 2 happens via this parameter, one alarm or a group of alarms can be chosen. With [P] the selection is confirmed and one changes into menu level.</p>
	<p>Back to menu group level, RET:</p> <p>With [P] the selection is confirmed and the device changes into menu group level „-REL-“.</p>

5.4.6. Alarm parameters

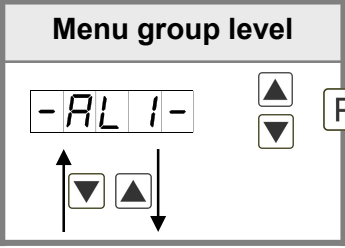
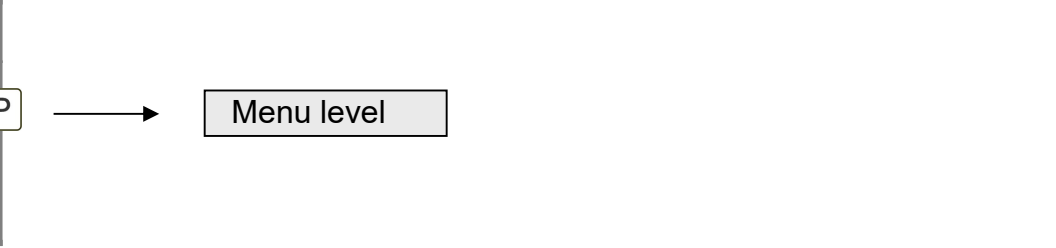
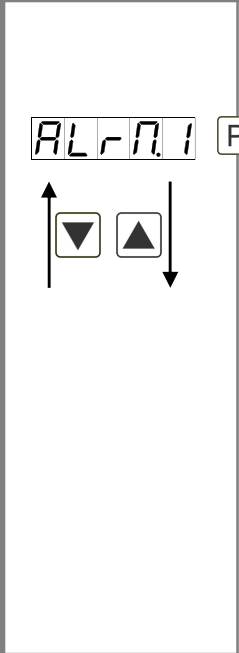
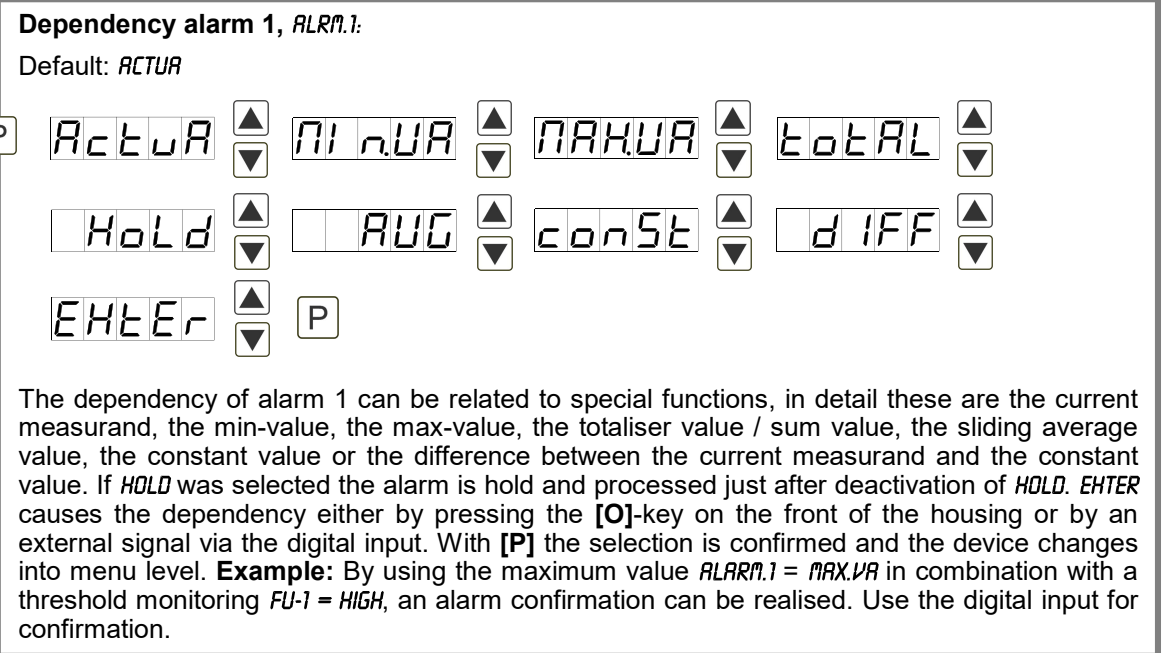
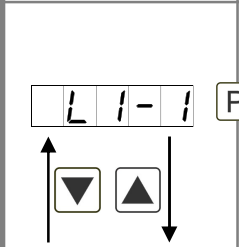
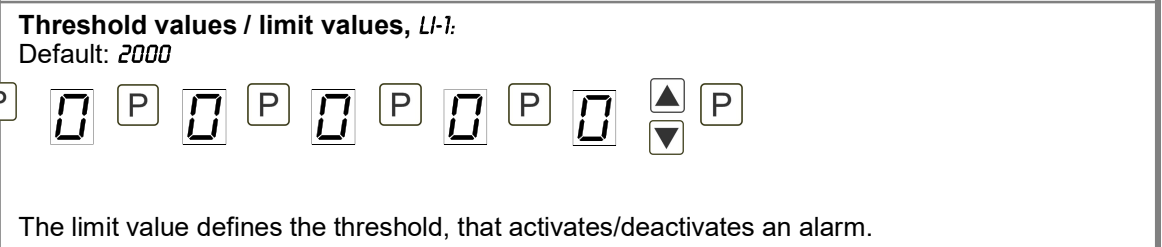
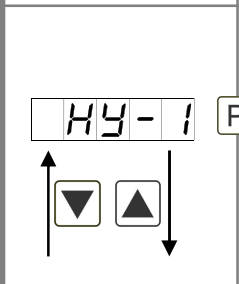
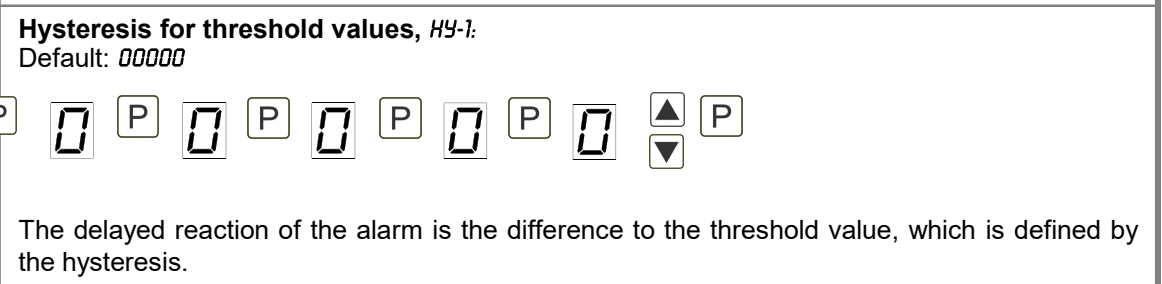
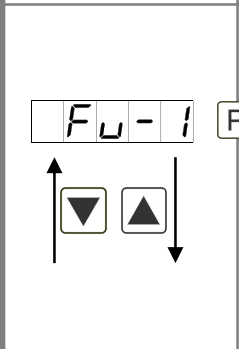
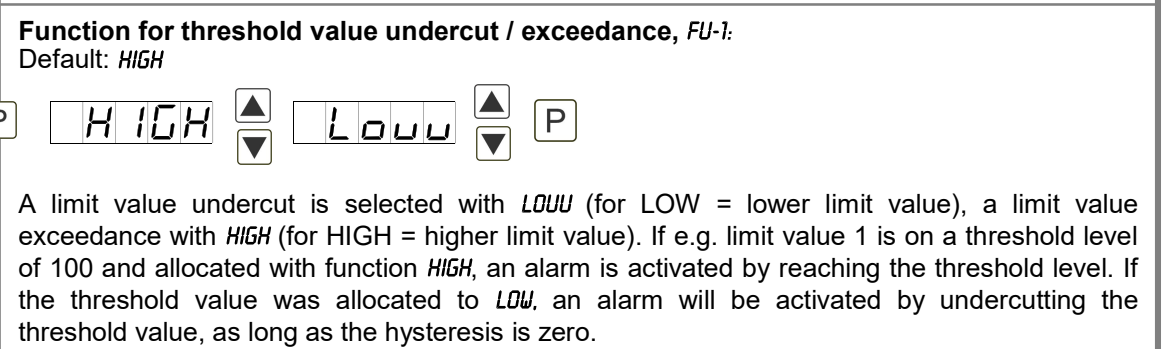
Menu group level		
		
Menu level	Parameterisation level	
	<p>Dependency alarm 1, ALRM.1: Default: <i>ACTUA</i></p>  <p>The dependency of alarm 1 can be related to special functions, in detail these are the current measurand, the min-value, the max-value, the totaliser value / sum value, the sliding average value, the constant value or the difference between the current measurand and the constant value. If <i>HOLD</i> was selected the alarm is hold and processed just after deactivation of <i>HOLD</i>. <i>ENTER</i> causes the dependency either by pressing the [O]-key on the front of the housing or by an external signal via the digital input. With [P] the selection is confirmed and the device changes into menu level. Example: By using the maximum value <i>ALARM.1 = MAX.VA</i> in combination with a threshold monitoring <i>FU-1 = HIGH</i>, an alarm confirmation can be realised. Use the digital input for confirmation.</p>	
	<p>Threshold values / limit values, LI-1: Default: <i>2000</i></p>  <p>The limit value defines the threshold, that activates/deactivates an alarm.</p>	
	<p>Hysteresis for threshold values, HY-1: Default: <i>00000</i></p>  <p>The delayed reaction of the alarm is the difference to the threshold value, which is defined by the hysteresis.</p>	
	<p>Function for threshold value undercut / exceedance, FU-1: Default: <i>HIGH</i></p>  <p>A limit value undercut is selected with <i>LOW</i> (for <i>LOW</i> = lower limit value), a limit value exceedance with <i>HIGH</i> (for <i>HIGH</i> = higher limit value). If e.g. limit value 1 is on a threshold level of 100 and allocated with function <i>HIGH</i>, an alarm is activated by reaching the threshold level. If the threshold value was allocated to <i>LOW</i>, an alarm will be activated by undercutting the threshold value, as long as the hysteresis is zero.</p>	





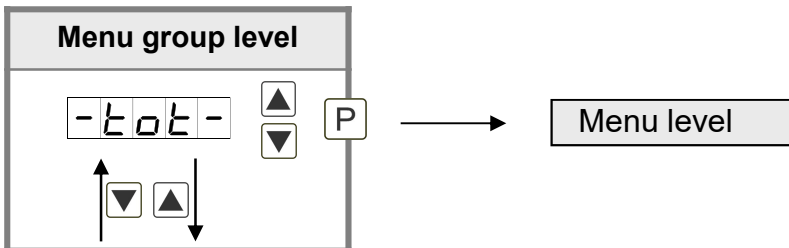

Menu level	Parameterisation level
	<p>Switching-on delay, <i>TON-1</i>: Default: 000</p> <p>0 P 0 P 0 P ▲ P ▼</p> <p>Preset a delayed switching-on of 0-100 seconds for limit value 1.</p>
	<p>Switching-off delay, <i>TOF-1</i>: Default: 000</p> <p>0 P 0 P 0 P ▲ P ▼</p> <p>Preset a delayed switching-off of 0-100 seconds for limit value 1.</p>
	<p>Back to menu group level, <i>RET</i>:</p> <p>With [P] the selection is confirmed and the device changes into menu group level „-AL1-“.</p>

The same applies to -AL2- to -AL4-.

5.4.7. Totaliser (Volume metering)

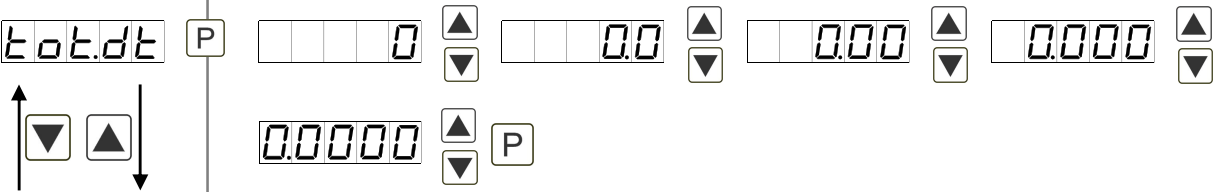

Menu level	Parameterisation level
	<p>Totaliser state, <i>TOTAL</i>: Default: OFF</p> <p>total P OFF STEAD TEMP P</p> <p>The totaliser realizes measurements on a time base of e.g. l/h, at this the scaled input signal is integrated by a time and steadily (select <i>STEAD</i>) or temporarily (select <i>TEMP</i>) saved. Select the constant storage for consumption measurements and the quick storage for frequently filling processes. During the constant storage <i>STEAD</i> the current sum value is saved at each totaliser reset. Furthermore it is saved every 30 minutes in the not-quick storage of the device. If <i>OFF</i> was selected, the function is deactivated. With [P] the selection is confirmed and the device changes into menu level.</p>
	<p>Time base, <i>T.BASE</i>: Default: SEC</p> <p>tbase P SEC min hour P</p> <p>Under this parameter the time base of the measurement can be preset in seconds, minutes or hours.</p>

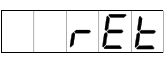
Menu level	Parameterisation level
	Totaliser factor, <i>FACTO</i>: Default: 1E0  <p>At this the factor (1E0...1E6) respectively the divisor for the internal calculation of the measuring value is assigned.</p>
	Setting up the decimal point for the totaliser, <i>TOT.DT</i>: Default: 0  <p>The decimal point of the device can be adjusted with the navigation keys [▲] [▼]. With [P] the selection is confirmed and the device changes into menu level.</p>
	Totaliser reset, <i>TOT.RE</i>: Default: 00000  <p>The reset value is adjusted from the smallest to the highest digit with the navigation keys [▲] [▼] and digit per digit confirmed with [P]. After the last digit, the display switches back to the menu level. The activator for the reset is parameter driven via the 4th key or via the optional digital input.</p>
	Back to menu group level, <i>RET</i>:  <p>With [P] the selection is confirmed and the device changes into menu group level „-TOT-“.</p>

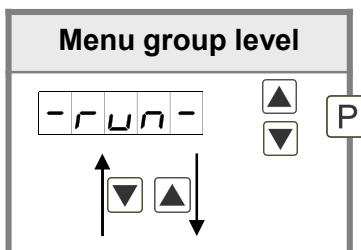
Programming interlock, *RUN*:

 Description see page 9, menu level *RUN*

6. Reset to factory settings

To return the unit to a **defined basic state**, a reset can be carried out to the default values.

The following procedure should be used:

- Switch off the power supply
- Press [P]-button
- Switch on voltage supply and press [P]-button until „- - - - -“ appears in the display.

With reset, the default values of the program table are loaded and used for subsequent operation. This sets the device back to the state in which it was supplied.

Caution! All application-related data are lost.

7. Alarms / Relays

This device has 4 virtual alarms that can monitor one limit value in regard of an undercut or exceedance. Each alarm can be allocated to an optional relay output S1-S2; furthermore alarms can be controlled by events like e.g. hold or min/max-value.

Function principle of alarms / relays	
Alarm / Relay x	Deactivated, instantaneous value, min/max-value, hold-value, totaliser value, sliding average value, constant value, difference between instantaneous value and constant value or an actuation via the digital input
Switching threshold	Threshold / limit value of the change-over
Hysteresis	Broadness of the window between the switching thresholds
Working principle	Operating current / quiescent current

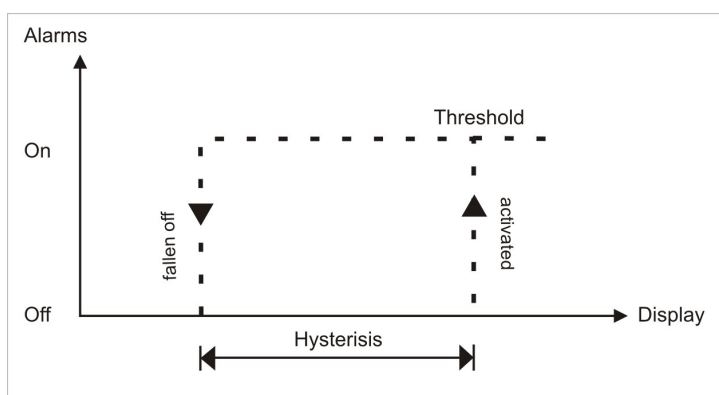

Operating current

By operating current the alarm S1-S2 is **off** below the threshold and **on** on reaching the threshold.

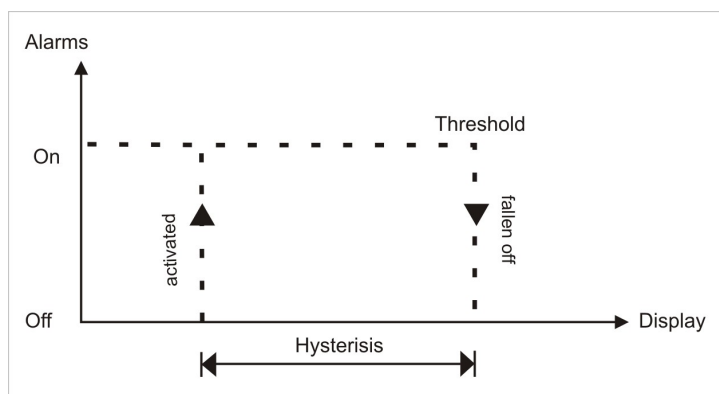

Quiescent current

By quiescent current the alarm S1-S2 is **on** below the threshold and switched **off** on reaching the threshold.

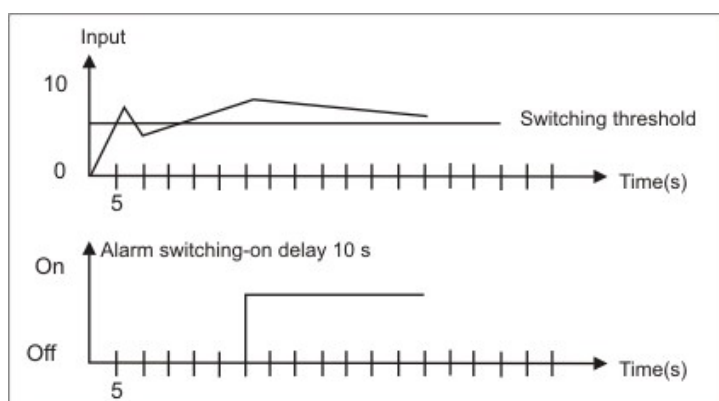

Switching-on delay

The switching-on delay is activated via an alarm and e.g. switched 10 seconds after reaching the switching threshold, a short-term exceedance of the switching value does not cause an alarm, respectively does not cause a switching operation of the relay. The switching-off delay operates in the same way, keeps the alarm / the relay switched longer for the parameterised time.

8. Sensor calibration offset / final value

The device is equipped with a semi-automatic sensor calibration (*SENSE*). A switching output operates the trimming resistor, which exists in some sensors. An adjustment of offset and final value takes place, after which the sensor can be used directly. Depending on parameterisation, the calibration can be realized via the 4th key or via the digital input. It is possible to key during the calibration steps. So, reference signals can be connected manually. However the calibration will be interrupted after 30 seconds.

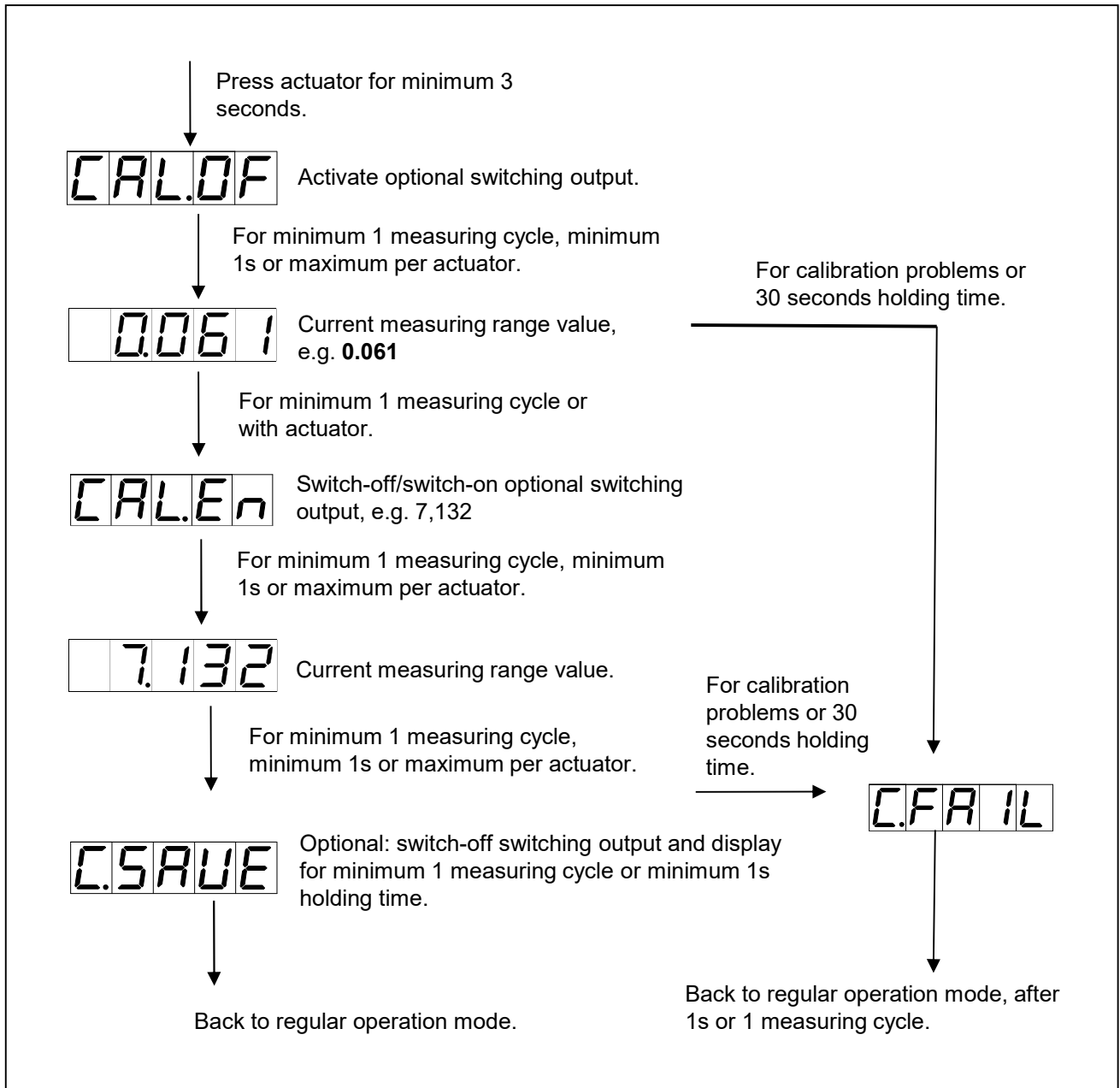

9. Technical data

Housing			
Dimensions	48x24x90 mm (BxHxD)		
	48x24x109 mm (BxHxD) incl. plug-in terminal		
Panel cut-out	45.0 ^{+0.6} x 22.2 ^{+0.3} mm		
Wall thickness	up to 3 mm		
Fixing	screw elements		
Material	PC Polycarbonate, black, UL94V-0		
Sealing material	EPDM, 65 Shore, black		
Protection class	standard IP65 (Front side), IP00 (Back side)		
Weight	approx. 200 g		
Connection	plug-in terminal; wire cross section up to 2.5 mm ²		
Display			
Digit height	10 mm		
Segment colour	red (optional green, yellow or blue)		
Range of display	-19999 to 99999		
Setpoints	one LED per setpoint		
Overflow	horizontal bars at the top		
Underflow	horizontal bars at the bottom		
Display time	0.1 to 10.0 seconds		
Input	Measuring range	Measuring error	Digit
> 1k Ω ... < 1.000 k Ω	1... 100 %	0.5 % of measuring range	± 1
Digital input	< 2.4 V OFF, 10 V ON, max. 30 VDC; R ₁ ~ 5 k Ω		
Accuracy			
Temperature drift	100 ppm / K		
Measuring time	0.1...10.0 seconds		
Measuring principle	U/F-conversion		
Resolution	approx. 18 bit at 1 second measuring time		
Output			
Analog output	0/4-20 mA / burden \leq 500 Ω ; 0-10 VDC / burden \geq 10 k Ω , 16 bit		
Switching outputs	2 PhotoMos (Closer)	30 VDC/AC, 0.4 A	
Power pack	100-240 VAC 50/60 Hz / DC \pm 10% (max. 5 VA) 24 VDC \pm 10% galv. isolated (max. 4 VA)		
Memory	EEPROM		
Data life	\geq 100 years at 25°C		

Ambient conditions	
Working temperature	0°C...50°C
Storing temperature	-20°C...80°C
Weathering resistance	0-80% relative humidity on years average without dew
EMV	EN 61326, EN 55011
CE-sign	Conformity according to directive 2014/30/EU
Safety standard	According to low voltage directive 2014/35/EU EN 61010; EN 60664-1

10. Safety advices

Please read the following safety advices and the assembly in *chapter 2* before installation and keep it for future reference.

Proper use

The **M3-75-device** is designed for the evaluation and display of sensor signals.



Danger! Careless use or improper operation can result in personal injury and/or can damage the equipment.

Control of the device

The panel meters are checked before dispatch and sent out in perfect condition. Should there be any visible damage, we recommend close examination of the packaging. Please inform the supplier immediately of any damage.



Installation

The **M3-75-device** must be installed by a suitably **qualified specialist** (e.g. with a qualification in industrial electronics).

Notes on installation

- There must be no magnetic or electric fields in the vicinity of the device, e.g. due to transformers, mobile phones or electrostatic discharge.
- **The fuse rating of the supply voltage should not exceed a value of 0.5A N.B. fuse!**
- Do not install **inductive consumers** (relays, solenoid valves etc.) near the device and **suppress** any interference with the aid of RC spark extinguishing combinations or free-wheeling diodes.
- Keep input, output and supply lines separate from one another and do not lay them parallel with each other. Position “go” and “return lines” next to one another. Where possible use twisted pair. This way best measuring results can be received.
- Screen off and twist sensor lines. Do not lay current-carrying lines in the vicinity. Connect the **screening on one side** on a suitable potential equaliser (normally signal ground).
- The device is not suitable for installation in areas where there is a risk of explosion.
- Any electrical connection deviating from the connection diagram can endanger human life and/or can destroy the equipment.
- The terminal area of the device is part of the service. Here electrostatic discharge needs to be avoided. Attention! High voltages can cause dangerous body currents.
- Galvanic isolated potentials within one complex need to be placed on an appropriate point (normally earth or machines ground). So, a lower disturbance sensibility against impacted energy can be reached and dangerous potentials, that can occur on long lines or due to faulty wiring, can be avoided.

11. Error elimination

	Error description	Measures
1.	The unit permanently indicates overflow. 	<ul style="list-style-type: none"> • The input has a very high measurement, check the measuring circuit. • With a selected input with a low voltage signal, it is only connected on one side or the input is open. • Not all of the activated supporting points are parameterised. Check if the relevant parameters are adjusted correctly.
2.	The unit permanently shows underflow. 	<ul style="list-style-type: none"> • The input has a very low measurement, check the measuring circuit. • With a selected input with a low voltage signal, it is only connected on one side or the input is open. • Not all of the activated supporting points are parameterised. Check if the relevant parameters are adjusted correctly.
3.	The word HELP lights up in the 7-segment display.	<ul style="list-style-type: none"> • The unit has found an error in the configuration memory. Perform a reset on the default values and reconfigure the unit according to your application.
4.	Program numbers for parameterising of the input are not accessible.	<ul style="list-style-type: none"> • Programming lock is activated • Enter correct code
5.	Err1 lights up in the 7-segment display	<ul style="list-style-type: none"> • Please contact the manufacturer if errors of this kind occur.
6.	The device does not react as expected.	<ul style="list-style-type: none"> • If you are not sure if the device has been parameterised before, then follow the steps as written in <i>Chapter 6</i> and set it back to its delivery status.