

Temperature metering KTY81-1xx - microprocessor based technology

- Standard: 2 setpoints, min/max memory - optional analogue output
- Mounting into panels with thickness up to 50 mm

72x36
8888

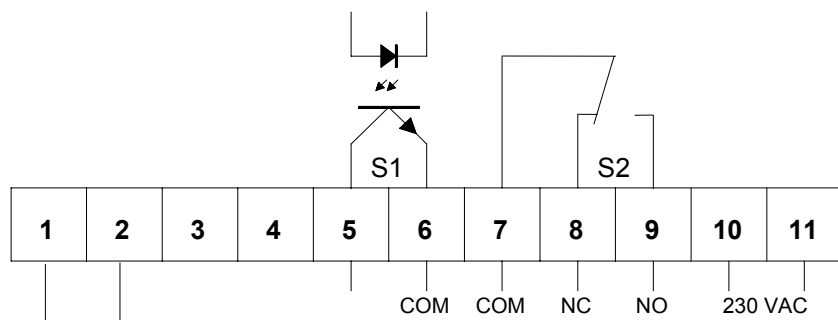
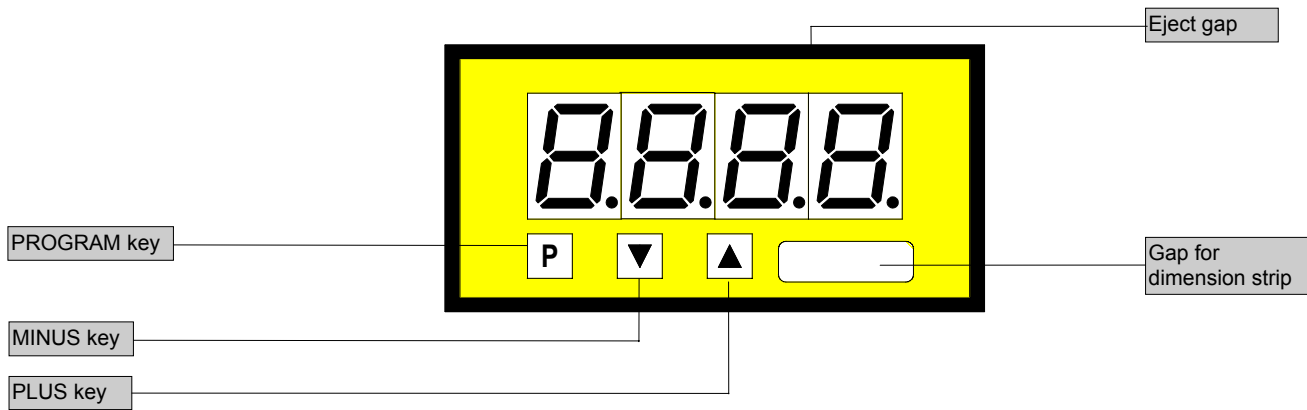

ORDER NUMBER OF TYPE
(-50,0...+150,0°C)
PTE 4.501.6522B

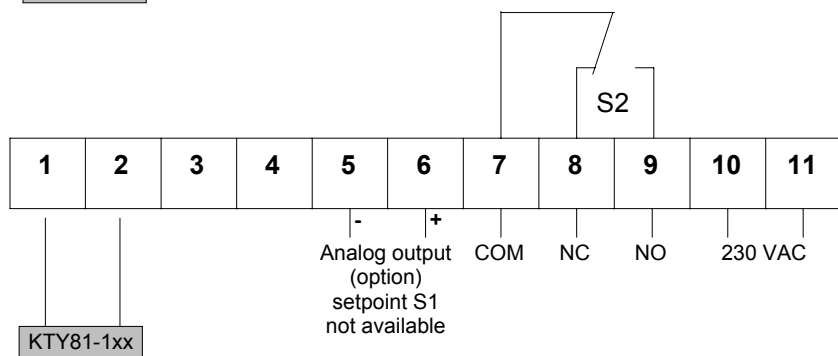

Power supply 115 VAC
galv. insulated (connection via terminal)

(-50,0...+150,0°C)
PTE 4.501.6422B

Power supply 24 VDC
galv. insulated (11=plus, 10=minus)

(-50,0...+150,0°C)
PTE 4.501.6722B

Options

- green LED
- Protection IP54
- Protection IP65
- Analog output 0-10 VDC (12 bit)
- Analog output 0-20 mA/load 500 Ω (12 bit)
- Analog output 4-20 mA/load 500 Ω (12 bit)
- Analog output 0-10 VDC (12 bit) *(supply voltage 24 VDC galv. insulated)*
- Analog output 0-20 mA/load 500 Ω (12 bit) *(supply voltage 24 VDC galv. insulated)*
- Analog output 4-20 mA/load 500 Ω (12 bit) *(supply voltage 24 VDC galv. insulated)*

With analog output setpoint S1 is not available!

- Dimension strips at selectable (max. 7 characters)
- Other power supplies on demand

Technical data

Dimensions	Housing	72 x 36 x 97 mm, including screw terminal	
	Assembly cut out	68.0 ^{+0.7} x 33.0 ^{+0.6} mm	
	Fastening	special quick plastic clamp proper to fix in wall thickness up to 50 mm	
	Housing material	PC/ABS-plastics blend, colour black, UL94V-0	
	Protective system	at the front IP40 connection IP00	
	Weight	approx. 0.190 kg	
	Connection	at the rear side via screw terminals up to 2.5 mm ²	
Input	KTY81-1xx	2 wire	
	Measuring range	-50.0.... +150.0 °C	
	Resolution	0.1°C	
	Sensor current	approx. 1 mA	
Output	Relay output	charge 240 VAC/0,25 A – 24 VDC/1 A; at ohm resistive burden	
	Switching cycles	2 * 10 ⁵ at max. contact rating 10 * 10 ⁶ mechanically	
	Open collector	supply by customers (U _B =5-40 V/I _{max} =100 mA)	
	Analogue output	0-10 VDC (12 bit)	} The analogue output is galvanic insulated from the measuring input!
		0-20 mA (12 bit) - load 500 Ohm	
	4-20 mA (12 bit) - load 500 Ohm		
Accuracy	Resolution	0.1°C	
	Measuring fault	1°C, +/- 10 digit (-20....100°C)/<-20°C max. 6°C +/- 10 digit/>100°C max. 2°C +/-10 digit	
	Temp. drift	100 ppm/K	
	Measuring principle	voltage/frequency converter	
Power unit	Supply voltage	230/115 VAC +/- 10 % (50-60 Hz), 24 VDC +/-10 % galvanic insulated	
	Power consumption	approx. 3 VA	
Indication	Display	LED with 7 segments, 14 mm high, red 4-digit = indication 9999	
	Overflow	indication of four transversal bars	
	Indication time	from 0.2 up to 10.0 seconds adjustable	
Ambient conditions	Working temperature	0 up to + 60 °C	
	Storing temperature	-20 up to + 80 °C	
Housing:			

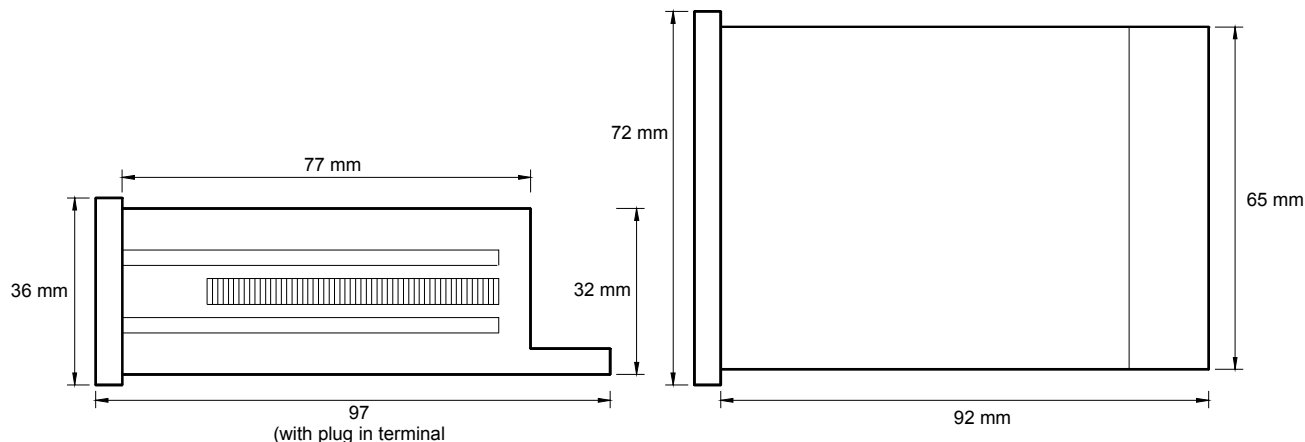

CE-sign

For unlimited use of the instrument within the directives for electromagnetic compatibility 89/336/EC measuring wires have to be used with shielded cable and cable's shield connected to earth ground at one end only.

Connection diagram, programming, remarks

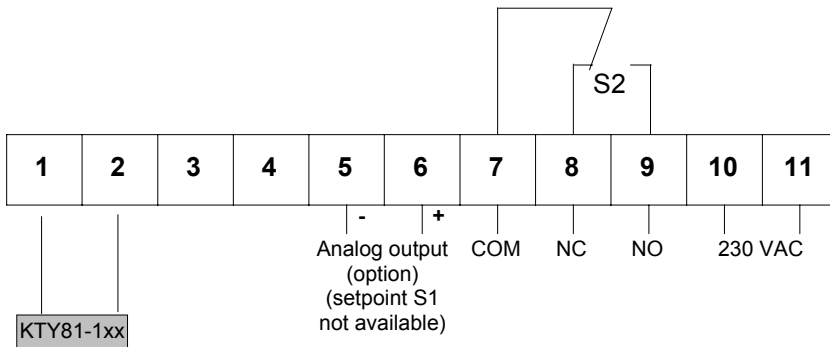
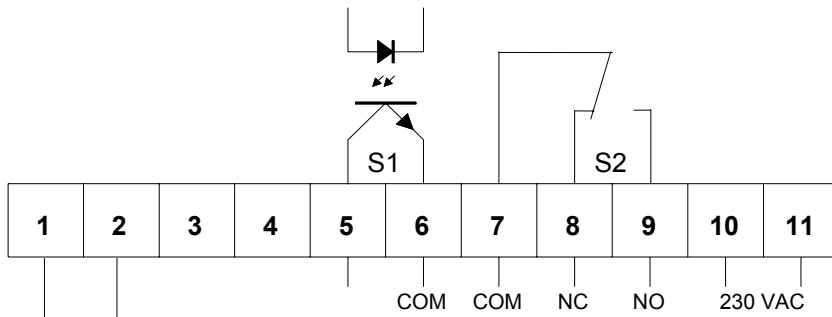

Setting

1. Connect the instrument according to the wiring diagram.
2. After power on, the instrument runs into a lamp test and returns back to the standard mode.
3. Pressing the **P**-key enters the program mode with indication of **P2** on the display.
4. Pressing the **P**-key and **▲**-key simultaneously steps through the different program numbers.
5. Pressing **▲** or **▼**-key shows the current values.
6. To change values use **▲** or **▼**-key.
7. The remaining values will be memorized automatically 7 seconds after the last touch of key with leaving program mode.

Additional key-functions in standard mode for indication of min/max values.

Simultaneously pressing of **▼** and **▲** key deletes and actualizes min/max-memory.
▲ key enters max-memory.
▼ key enters min-memory.

Instructions

After power on the instrument with his inbuilt microcontroller starts with an initial program activating lamp test and readout of memorized parameters in an EEPROM.

The following diagrams are showing the switching operation of PTE4 relay contacts. The hysteresis is free programmable. There are two kinds of operation:

Example: operation current

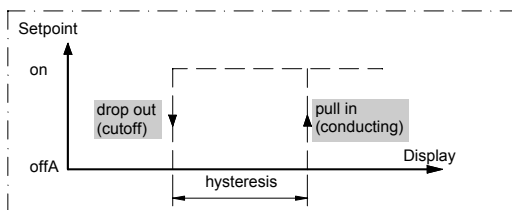

Example: quiescent current

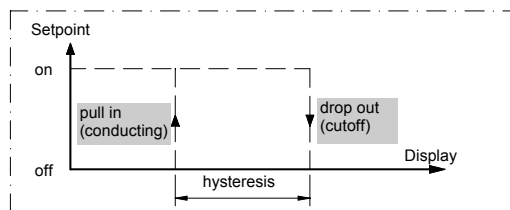

Operation current means that the open collector will be pulled in (conducting) if reaching the adjusted setpoint.

Quiescent current means that the open collector will be dropped out (cutoff) if reaching the adjusted setpoint.

Operation, setting instructions

subject of technical alteration – status 02/2006 - PTE4K816GB.DOC

Program table 1

Program-Number (PN)	Function	Remark	Display	Basic parameters after reset
2	Sensor and line balancing	Temperature is displayed	0 to +/-20.0	0.0
3	Selection between °C or °F	Celsius=0 / Fahrenheit=1	0/1	0
4	Input of display time	Display time = measuring time Method of measurement integrating	0.2 to 10.0 seconds	1.0
5	Input of final value for analog output	Option	-999 to +9999	500.0
6	Input of offset for analog output	Option	-999 to +9999	0.0

Program table 2 (setpoints)

S1 PN	S2 PN	Function	Display	Basic parameters after reset
61	66	Setpoint	-999 to +9999	100.0/150.0
62	67	Hysteresis	0 to +9999	0.1/0.1
63	68	Quiescent current	0	-
		Operating current	1	1/1

Example for programming

Temp. sensor: KTY81-1xx
Connection: 2-wire
Analog output: 0.0 up to 70°C
Display refr. time: 2.0 seconds
Setpoints:
 S1 ==> 30.0 and quiescent current
 open collector conducting = 28.0 ==> hysteresis 2.0
 S2 ==> 70.0 and operation current
 relay drop out = 40.0 ==> hysteresis 30.0

Analog output: 0 V output ==> display 0.0 ==> 0.0°C
 (no setpoint S1) 10 V output ==> display 70.0 ==> 70.0°C

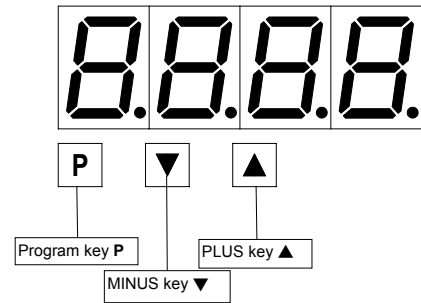

The basic adjustments concerning to the following program example are the ground parameters after a total reset occurring through a power on with pressing **P**-key (see previous page).

Program advices:

Pressing the **P**-key enters **always** the program mode with program number 2. The **P2** starts to blink in change with the current value after 3 seconds. After further 4 seconds, the system leaves the program mode and goes to the standard mode. In program mode pressing **▼** or **▲**-key selects the current values which are free scalable with both the keys. All the other parameters will be memorized automatically after leaving program mode.

Programming

Switch power on!

Lamp test



Standard mode

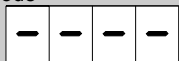

Set KTY84 Simulator to 0°C.
The indication value depends on the used cable length.



To program number 2 with **P**.

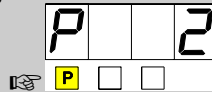

To memorized value with **▼** or **▲**.



Sensor and line balancing.



To program number 3 with **P** and **▲**.

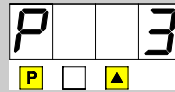

To memorized value with **▼** or **▲**.

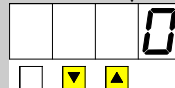

To program number 4 with **P** and **▲**.

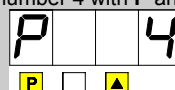

Example for programming

To memorized value with ▼ or ▲.

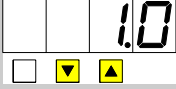

Set display time.

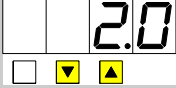

The following programming steps are necessary for the setpoint programming of S1 and S2 only.

To program number 61 with P and ▲.

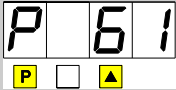

To memorized value with ▼ or ▲.



Set free scalable value for setpoint S1.



To program number 62 with P and ▲.

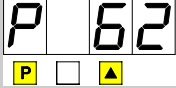

To memorized value with ▼ or ▲.

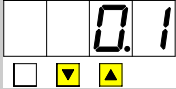

Set hysteresis for S1.



To program number 63 with P and ▲.

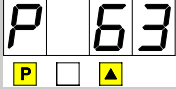

To memorized value with ▼ or ▲.

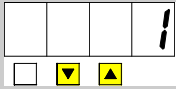

Set quiescent current.

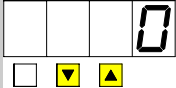

To program number 66 with P and ▲.



To memorized value with ▼ or ▲.



Set free scalable value for setpoint S2.



To program number 67 with P and ▲.



To memorized value with ▼ or ▲.

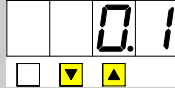

Set hysteresis for S2.



To program number 68 with P and ▲.

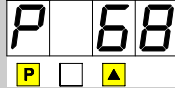

To memorized value with ▼ or ▲.

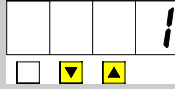

Set operating current.

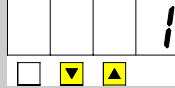

Programming finished.

All programmed values are memorized after 7 seconds. Jumps back into standard mode automatically.

The program numbers 5 and 6 are available with option analogue output only.

To program number 5 with P and ▲.



To memorized value with ▼ or ▲.



Set free scalable final indication value for analog output.

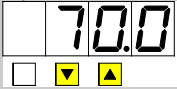

To program number 6 with P and ▲.

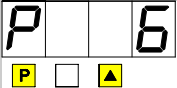

To memorized value with ▼ or ▲.

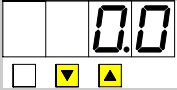

Programming finished.

All programmed values are memorized after 7 seconds. Jumps back into standard mode automatically.

Setting possibilities of the jumper field on the rear side.

