



**M3 – 5-digit digital panel meter in 96x24 mm (BxH)  
Frequency 0.01 Hz to 999.99 kHz / 0.01 Hz to 9.9999 kHz / 0-2.5000 kHz  
Connection for Namur, 3-wire NPN/PNP, position survey via  
incremental encoder (HTL- or TTL-output)**

- red display from -19999...99999 digits (optional green, orange, blue or tricolour display)
- installation depth: 120 mm without plug-in screw terminal
- multi voltage power supply unit 100-240 VAC, alternatively 10-40 VDC galvanic isolated
- adjustment via factory setting or directly on the sensor signal
- min/max-memory with adjustable permanent display
- 30 additional adjustable support points
- display flashing at threshold value exceedance / undercut
- Schmitt-Trigger-Input
- digital frequency filter for contact bounce suppression and interference suppression
- frequency filter with different pulse-duty factor
- navigation keys for the triggering of Hold, Tara, display change, setpoint setting, alarm actuation
- flexible alarm system with adjustable delay times
- volume measurement (Totaliser) for frequencies up to 1 kHz (pulse exact)
- mathematical functions like reciprocal value, square root, square and rounding
- constant setting / setpoint setting
- sliding averaging
- brightness control via parameter or front keys
- programming interlock via access code
- protection class IP65 at the front
- plug-in screw terminal
- optional: 1 or 2 relay outputs
- optional: 1 independently scalable analog output
- optional: interface RS232 or RS485
- accessories: pc-based configuration-kit PM-TOOL with USB adapter
- on request: devices for working temperatures of -20°C...60°C or -40°C...70°C

- Frequency (0.01 Hz to 999.99 kHz)

- Frequency (0.01Hz to 9.9999 kHz for transmitter / 0 to 2.5000 kHz for position survey)

Supply 100-240 VAC, DC ± 10% **M3-3FR5B.0307.S70xD** 264.80

Supply 10-40 VDC, 18-30 VAC **M3-3FR5B.0307.W70xD** 270.10

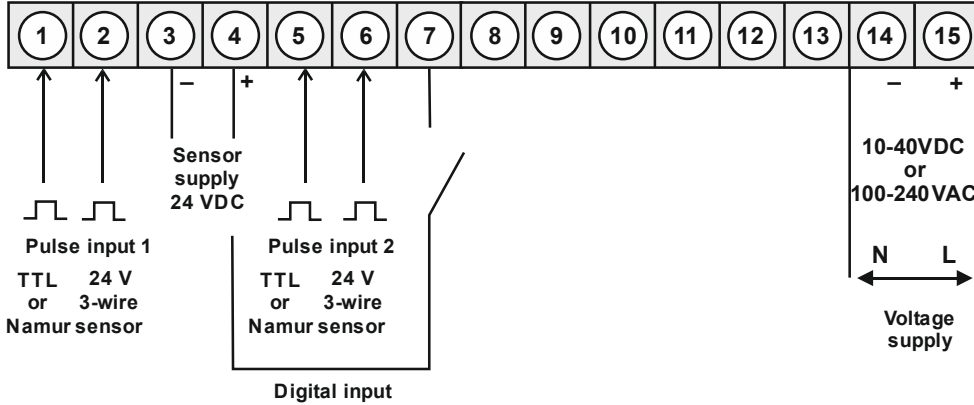

**Options:**

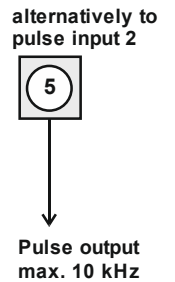
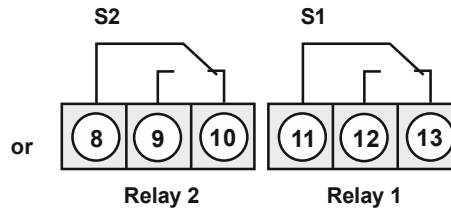
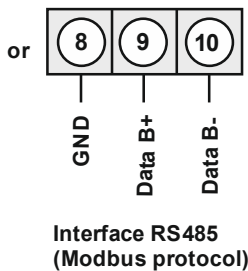
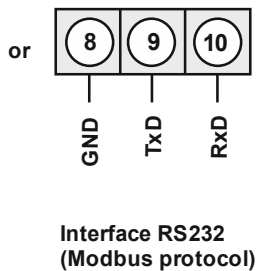
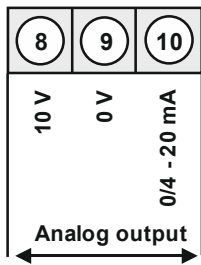

**Alternatively to analog output**

**Advice:** Using Namur sensors with a nominal voltage of approx. 8 V, a sensor supply of 10 VDC needs to be provided.

**Product key options**

M	3-	3	F	R	5	B.	0	3	0	7.	S	7	0	x	D
M	3-	3	F	R	5	B.	0	3	0	7.	W	7	0	x	D

	EUR	
D	Dimension/physical unit, customer-specific settings	20.00
1	1 relay output (with option analog output only 1 switching point is possible)	21.20
2	2 relay outputs	31.80
1	without keypad, operation via parameterisation software PM-TOOL	10.60
X	Analog output 0/4-20 mA, 0-10 VDC	105.90
2	Sensor supply 10 VDC / 50 mA incl. digital input	16.30
K	Pulse output	10.60
3	Interface RS232 galv. isolated	68.80
4	Interface RS485 galv. isolated	68.80
B	Blue	46.60
G	Green	10.10
Y	Orange	10.10
T	Tricolour (Red-Green-Orange)	31.80

On demand state dimension unit on order, e.g. U/min.

**Parameterisation software**

PC based configuration software PM-Tool for devices without keypad, for a simple adjustment of standard devices, incl. USB-adapter. Programming happens via an interface on the back.

**PM-TOOL-MUSB4**

**94.30**

• **Technical data**

<b>Dimensions</b>	Housing	B96 x H24 x D120 mm, (incl. plug-in terminal D= 145 mm cable outlet at the back)
	Panel cut-out	92.0 <sup>+0.8</sup> x 22.2 <sup>+0.3</sup> mm
	Fixing	Screw elements for a wall thickness up to 10 mm
	Housing material	PC Polycarbonate, black
	Sealing material	EPDM, 65 Shore, black
	Protection class	at the front IP65 Standard, at the back IP00
	Weight	approx. 250 g
	Connection	plug-in terminal; wire cross section up to 2.5 mm <sup>2</sup>
<b>Display</b>	Display	5-digit
	Digit height	14 mm
	Segment colour	red (Standard), optional in green, orange, blue or tricolour (red/green/orange)
	Range of display	-19999 to 99999
	Threshold value	optical display flashing
	Overflow	horizontal bars at the top
	Underflow	horizontal bars at the bottom
<b>Measuring input</b>	Signal	Pulse input, TTL, Namur, 3-wire initiator PNP/NPN
	Input resistance	R <sub>i</sub> at 24 V / 4 kΩ HTL-level >15 V / < 4 V TTL-level >4.6 V / <1.9 V
	Input frequency	0.01 Hz selectable up to 999.99 kHz 0.01 Hz to 9.9999 kHz for speed transmitter, 0 to 2.5000 kHz for position survey
	Measuring fault	0.05% of measuring range
<b>Output</b>	Relay	with change-over contact 250 V / 2 AAC, 30 V / 2 ADC
	Switching cycle	30 * 10 <sup>3</sup> at 2 AAC, 2 ADC Ohm resistive burden, 10 * 10 <sup>6</sup> mechanically Separation according to DIN EN50178 / Specific values according to DIN EN 60255
	Pulse output	max. 10 kHz
	Analog output	0-10 VDC / burden ≥ 10 kΩ, 0/4-20 mA / burden ≤ 500 Ω, 16 bit
	Sensor supply	24 VDC / 50 mA; 10 VDC / 50 mA
<b>Digital input</b>	Input galv. isolated	< 2.4 V OFF; >10 V ON; max. 30 VDC, R <sub>i</sub> ~ 5 kΩ
<b>Interface</b>	Protocol	Modbus with ASCII or RTU-protocol
	RS232	9.600 Baud, no parity, 8 DataBit, 1 StopBit, pipeline length max. 3 m
	RS485	9.600 Baud, no parity, 8 DataBit, 1 StopBit, pipeline length max. 1000 m
<b>Power pack</b>	Supply	100-240 VAC 50/60 Hz, DC ±10 % (max. 10 VA) 10-40 VDC galv. isolated, 18-30 VAC (max. 10 VA)
<b>Memory</b>	EEPROM	Data preservation ≥ 100 years at 25°C
<b>Ambient condition</b>	Working temperature	0 to +50°C
	Storing temperature	-20 to +80°C
	Climatic density	relative humidity 0-85% on years average without dew
<b>CE-sign</b>	Conformity to directive 2014/30/EU	
<b>EMV</b>	EN 61326, EN 55011	
<b>Safety standard</b>	According to low voltage directive 2014/35/EU, EN 61010; EN 60664-1	

**Housing:**

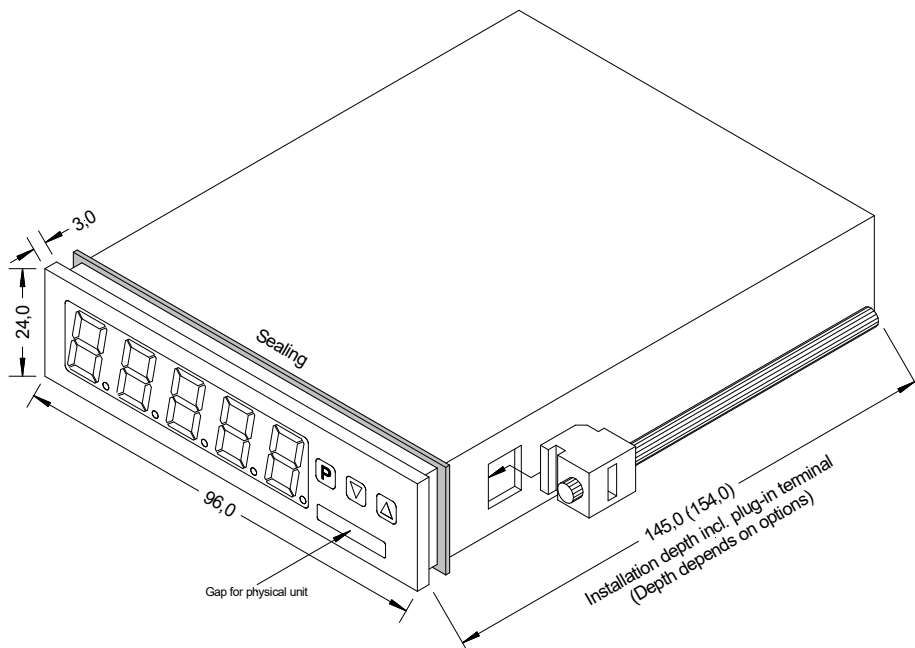

• Order key

	M	3-	3	F	R	5	B.	0	3	0	7.	W	7	0	x	D		
<b>Standard type M-Line</b>																		<b>Dimension</b>
																		<input type="checkbox"/> D physical unit
<b>Installation depth</b>																		<b>Version</b>
145 mm incl. plug-in terminal (154 mm)			<input type="checkbox"/> 3															<input type="checkbox"/> x internal version
<b>Housing size</b>																		<b>Switching points</b>
96x24x120 mm (BxHxD)			<input type="checkbox"/> 3															<input type="checkbox"/> 0 without
<b>Display type</b>																		<input type="checkbox"/> 1 1 relay output
Frequency				<input type="checkbox"/> F														<input type="checkbox"/> 2 2 relay outputs
<b>Display colours</b>																		<b>Protection class</b>
Blue							<input type="checkbox"/> B											<input type="checkbox"/> 1 without keypad, operation via PM-TOOL
Green							<input type="checkbox"/> G											<input type="checkbox"/> 7 IP65 / plug-in terminal
Red							<input type="checkbox"/> R											
Red/Green/Orange							<input type="checkbox"/> T											
Orange							<input type="checkbox"/> Y											<b>Supply voltage</b>
<b>Number of digits</b>																		<input type="checkbox"/> S 100-240 VAC
5-digits									<input type="checkbox"/> 5									<input type="checkbox"/> W 10-30 VDC
<b>Digit height</b>																		<b>Measuring input</b>
14 mm									<input type="checkbox"/> B									<input type="checkbox"/> 7 Frequency
<b>Interface</b>																		<b>Analog output</b>
without									<input type="checkbox"/> 0									<input type="checkbox"/> 0 without
Interface RS232									<input type="checkbox"/> 3									<input type="checkbox"/> X 1x 0-10 VDC, 0/4-20 mA
Interface RS485									<input type="checkbox"/> 4									
																		<b>Sensor supply</b>
																		<input type="checkbox"/> 0 without
																		<input type="checkbox"/> 3 24 VDC / 50 mA (incl. digital input)
																		<input type="checkbox"/> 2 10 VDC / 50 mA (incl. digital input)
																		<input type="checkbox"/> K 24 VDC / 50 mA (incl. digital input and frequency output max. 10 kHz)